



AEROMOTIVE

Part # 18364

2005-2018 GM Truck Tank Depths 6"-16" Phantom Triple Fuel Pump / Baffle System INSTALLATION INSTRUCTIONS

This product is not legal for sale or use on emission-controlled vehicles except when used as a direct replacement part matching OEM specification.

WARNING!



Always be aware of flammable situations. Drilling and grinding can be potential ignition sources. Extinguish all open flames, prohibit smoking and eliminate all sources of ignition in the area of the vehicle and workspace before proceeding with the installation. Ensure you are working in a well-ventilated area with an approved fire extinguisher nearby.

WARNING!



etc.

Installation of this product requires modification to a fuel tank/ the fuel system, failure to satisfy all safety considerations will result in fire, explosion, injury and/or loss of life to yourself and/or others. All fuel system components **MUST** be located as far from heat sources as possible, like exhaust, engine block,

WARNING!



Mechanical and hydraulic lifting devices can tip over or lower accidentally due to incorrect maneuvering or technical errors. A falling object can cause injury and/or loss of life to yourself and/or others. When working under the vehicle, always use stands, and ensure that the ground or floor is stable and level. Never crawl under a vehicle which is only supported by a jack.

WARNING!



The fuel system is under pressure. Do not open the fuel system until the pressure has been relieved. Refer to the appropriate vehicle service manual for the procedure and precautions for relieving the fuel system pressure.

CAUTION!



When installing this product always wear safety glasses and other appropriate safety apparel. A drilling operation will cause flying metal chips. Flying metal chips can cause eye injury.

CAUTION:



Installation of this product requires detailed knowledge of automotive systems and repair procedures. We recommend that this installation be carried out by a qualified automotive technician. Careless installation of this product can result in damage to the product, injury or loss of life to yourself and/or others.

Compatible Fuels:

Pump Gas
Race Gas
E85
Alcohol/Ethanol

Parts Included:

3ea Fuel Pump (PN: 11545)	4ea Ring Terminal (10-12 GA Yellow for Pump)
3ea Fuel Pump Strainer	2ea Ring Terminal (22-16 GA Red for Optional Level Sensor)
1ea Fuel Pump Hanger Assembly	6ea Ring Terminal Cap
1ea Fuel Pump Foam Baffle Assembly	1ea Hose Clamp
1ea Foam Extension Piece	4ea Pump Clamp
1ea Brass Tee (Return Hose Fitting)	
1ea Pump Spacer	
2ea Set Screws	

Tools / Supplies Needed:

Tape Measure	Flat Screwdriver
Bread Knife	Lock Ring Remover Tool
Hacksaw Blade/Saw	1/8" Allen Wrench
Tubing Cutter (Metal Shears)	9/16" Wrench

Parts Required: (Not Included)

**1 – OEM Replacement Fuel Pump Gasket
PN: AC Delco G41 (#22682111)**

The following list are part numbers for sending unit brackets and the level sensor that they are designed for. All brackets are made for 1500 series vehicles.

- 1 – Aeromotive P/N: 18713 for 2005-2007 Silverado/Sierra 1500 series**
 - Works with WVE 5S13490 level sensor see figure 4-1 below
- 1 – Aeromotive P/N: 18715 for 2008-2014 Silverado/Sierra 1500 series**
 - Works with AC Delco SK1293 level sensor see figures 4-2 below
- 1 – Aeromotive P/N: 18716 for 2015-2018 Silverado/Sierra 1500 series**
 - Works with AC Delco 13582492 level sensor see figure 4-3 below
- 1 – Aeromotive P/N: 18714 for 2005-2009 Trailblazer**
 - Works with Dorman 911013 level sensor see figure 4-4 below

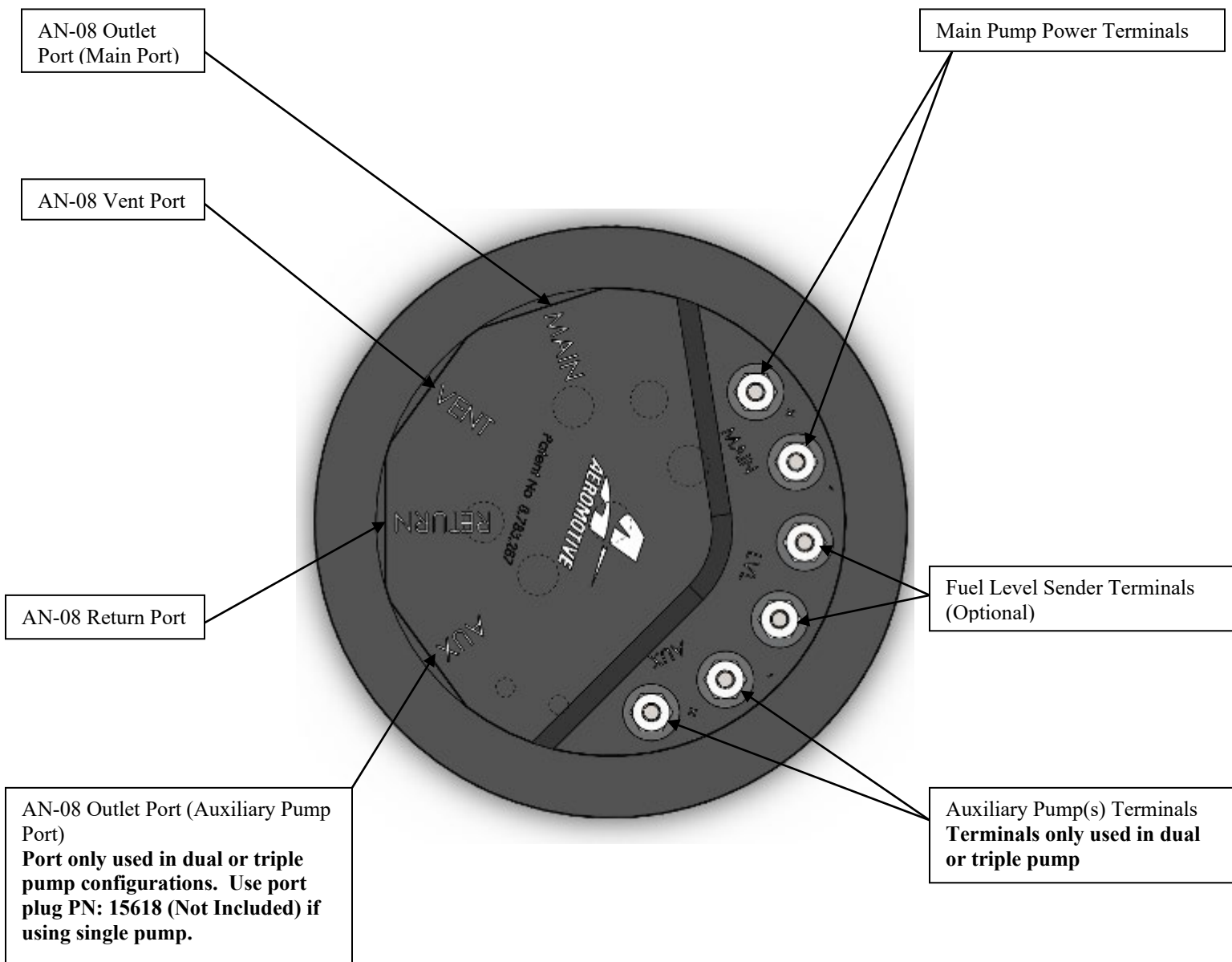

The enclosed Aeromotive fuel pump assembly utilizes an o-ring sealed AN-08 style feed, return and vent ports. These ports seal with o-rings; these ports are **NOT PIPE THREAD** and utilize **NO THREAD SEALANT**.

The fuel pump used in this tank is the Aeromotive Stealth 450. To ensure proper pump function and life, we strongly recommend the following:

- Utilize AN-08 (EFI) or (carb) size high pressure fuel lines, fittings and o-rings for all connections from the fuel tank to the engine, including the supply and return lines.
- Install a 10 micron post-filter (Aeromotive p/n 12321 or 12377 for individual outlets or 12311 for all three pumps)
- Install a remote-mount rollover valve. It must be mounted in a vertical position and mounted as high or higher than your filler tube.
- Fuel pump wiring should be 8-gauge wire and triggered with a relay rated for a minimum of 40 amps for the “Auxiliary” (2x pumps) control, 10-gauge wire and 20 amps minimum for the “Main” (1x pump) control.
- A return style or bypass regulator must be used (Aeromotive p/n 13305 for EFI, 13202 for carb).

Failure to follow the above recommendations may result in fuel leakage, bursting of the fuel lines, poor vehicle performance and/or decreased fuel pump life! Improper installation will void all warranties for this product!

Pump Specifications:

	18358 Kit (Pump: 11545)	
Outlet pressure/typical flow:	10 psi / 3x 454 LPH @ 13.5 V 40 psi / 3x 430 LPH @ 13.5 V 60 psi /3x 381 LPH @ 13.5 V	
Continuous Operating Range:	5 psi – 65 psi @ 13.5 V	
Pump internal By-Pass Pressure:	120 psi	
Current Draw:	3x 15.3 amps @ 40 psi	

Aeromotive Commonly Used Fittings

- | | |
|--|--|
| 15607 AN-08 ORB to AN-08 Flare (Inlet/outlet/vent fitting) | For AN-08 fuel lines |
| 15606 AN-06 ORB to AN-06 Flare (Inlet/outlet/vent fitting) | For AN-06 fuel lines |
| 15649 AN-06 ORB to AN-08 Flare (Inlet/outlet/vent fitting) | For AN-06 fuel lines |
| 15609 AN-10 ORB to AN-06 Flare (fuel filter fitting) | For AN-08 fuel lines |
| 15610 AN-10 ORB to AN-08 Flare (fuel filter fitting) | For AN-06 fuel lines
For AN-08 fuel lines |

Aeromotive AN-10 Fuel Filter P/N's

- | | |
|------------------------------------|--|
| 12301 Red 10-micron Fuel Filter | 12377 Black 10-micron Fuel Filter, Male Ends |
| 12321 Black 10-micron Fuel Filter | 12311 Black Hardcoat 10-Micron Fuel Filter |
| 12351 Chrome 10-micron Fuel Filter | |
| 12335 Red 40-micron Fuel Filter | |
| 12305 Fuel Filter Bracket | |

Aeromotive Electrical Components

- 16301 Standard Fuel Pump Wiring Kit
- 16307 Deluxe HD Fuel Pump Wiring Kit
- 16306 Fuel Pump Speed Controller

Aeromotive system components are not legal for sale or use on emission-controlled motor vehicles.

CAUTION:



Aeromotive Phantom Components, including the Phantom 450 Stealth Pump and the patented Foam and Bladder Baffle assembly, have been thoroughly tested for use in common pump gas, non-oxygenated racing gas, ethanol including E85 from corn, and petroleum based (not-bio) diesel fuel. Blending fuels and/or additives, including cleaners, stabilizers or octane boosters, cannot be tested and could result in damage to Phantom system components or other components in the fuel system. These failures cannot be anticipated and may not be covered under warranty. Contact the Aeromotive Tech Department with any questions on blending of fuels and/or use of additives.

The following steps are typical of most installations:

1. Once the engine has been allowed to cool, disconnect the negative battery cable and relieve the fuel system pressure, referring to the appropriate vehicle service manual for the procedure and precautions for doing so.
2. Raise the vehicle on stable level ground and support it with jack stands.
3. Referring to the appropriate vehicle service manual for instructions, drain, disconnect any electrical and fuel system component connections and remove the OEM fuel tank. Remove the OEM fuel pump assembly by removing the lock ring, (note the position of the OEM fuel line connections to the fuel pump assembly). The removal of the vehicles exhaust system may be necessary for fuel tank removal.



This Aeromotive Phantom Fuel Pump System is intended to be installed into a NEW fuel tank that does NOT, and has NEVER contained fuel. If you choose to install this product into a fuel tank that has had fuel introduced to it, proceed at your own risk.



The fuel tank must be professionally cleaned to remove all traces of any combustible fluids. Failure to properly clean and remove all combustible fluids from the fuel tank will result in injury or loss of life to yourself and/or others.

4. With the new cleaned fuel tank on your preferred work surface, ensure you have all components listed above to complete the installation.
5. Using a tape measure, determine the depth of the tank at the OEM fuel pump assembly location by measuring from the bottom of the tank to the gasket sealing surface.



6. Measure the foam baffle assembly from the bottom (black rubber part) up and mark the assembly 1" longer than the determined tank depth. (If the tank was 8.00" deep, mark the foam baffle assembly to be 9.00" long). Some tanks will require the use of the provided extra length of foam. If the tank depth is greater than 11.00", you will need to use the extra length of foam to achieve the proper foam length. Using a bread knife or fine-tooth hacksaw blade, carefully cut the shorter of the two pieces of foam baffle to the desired length. To use both lengths of foam, insert the shorter length into the rubber bladder, then stack the longer length on top of the shorter length.

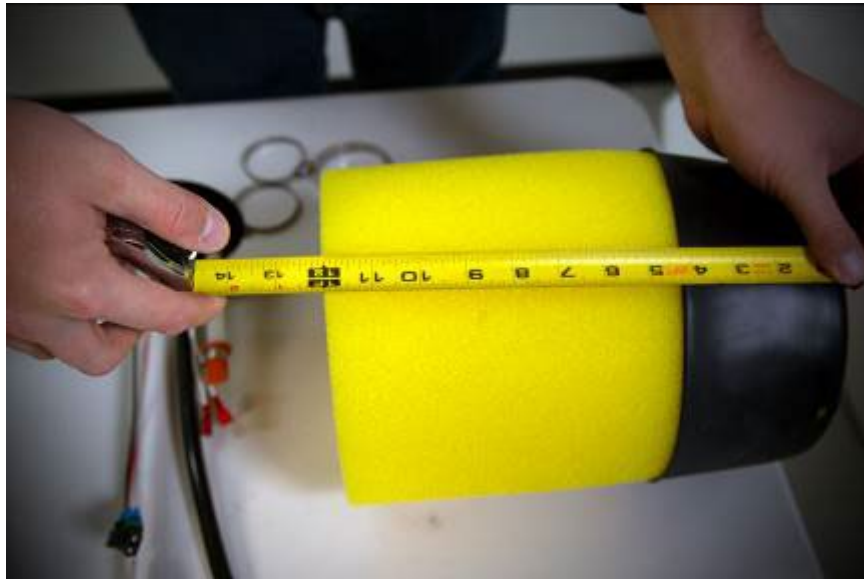

7. Compress the baffle assembly, and insert it in the tank being careful not to cut the assembly or your hands on the tank edge. Once the baffle assembly is in the tank, manipulate it until it's centered within the opening. If using two lengths of foam, ensure the two lengths are concentric with each other and also with the sending unit hole. **(Note: If you are fabricating a bracket to use with the level sender, you will need to cut a "window" in the foam to allow your fabricated bracket/level sender to pass through. Do not cut into the black rubber part of the baffle assembly).**



8. Install fuel pump strainers (pre-filters) on the fuel pumps.



9. Position the fuel pump(s) on the fuel pump hanger rod such that from the bottom of the outlet cap to the bottom of the fuel pump strainer is equal to the fuel tank depth. Mark the pump hanger rod and the black outlet hoses so they may be cut to the necessary lengths. Remember, take the time to measure twice and cut once!

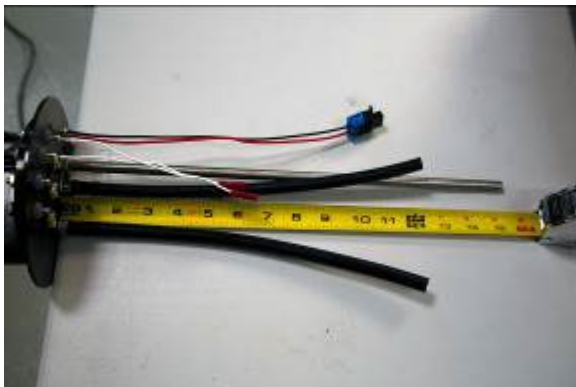

Note: Failure to position the fuel pump strainer on the bottom of the basket assembly will potentially starve the pump for fuel when fuel tank level is low, yielding poor drivability and reduced pump performance.

Note: 2 – 10-24 Tapped holes are provided on the bottom side of the outlet cap that can be used for a fabricated bracket to accommodate a fuel level sensor. Due large variations in level sensors a universal bracket is not available, but there are four brackets for specific applications as listed above. The two white wires connected to the “LVL” terminals on the bottom of the outlet cap are provided to make a connection between a level sensor and the outlet cap. If you are not using a level sensor, tie the two white wires out of the way as they will not be used.

10. Cut the black outlet hoses to the desired length. Cut the return hose such that is approximately 3 inches less than the pump depth to ensure that the return outlet tee is well above the pump inlets (to reduce possible turbulence and air entrapment at low fuel levels) but still below the top of the fuel basket. Insert the brass tee into the return hose and tighten with a small hose clamp, orient the fitting so it does not spray directly onto the fuel pump(s).

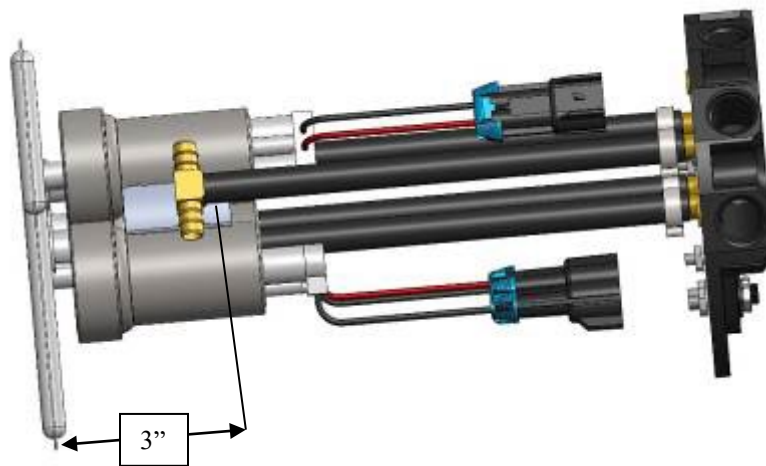
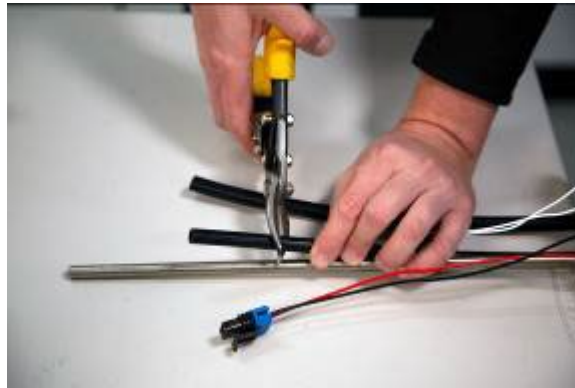

11. Using a metal cutting saw cut the pump hanger rod to the desired length, removing enough at the bottom to ensure that the end of the rod will not contact the fuel pump strainer or fuel pump bells on 450 pumps.



12. Slide the small hose clamps onto each of the pump(s) outlet hoses. Insert the pump outlets into the black outlet hoses with the pump separator between and near the bottom of the hanger rod. Position the pumps and separator such that each pump outlet hose is nearly straight. Once the pumps and pump spacer is properly aligned, fully tighten the small hose clamps to secure the pumps to the outlet hoses.

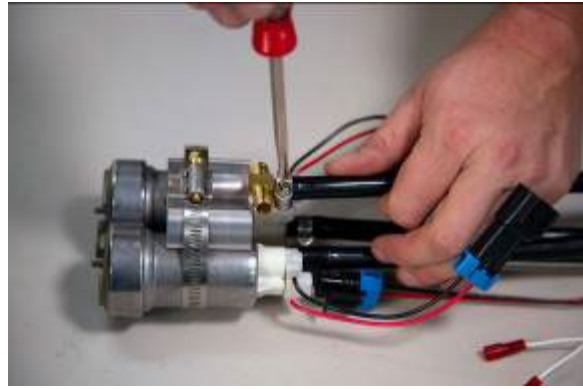
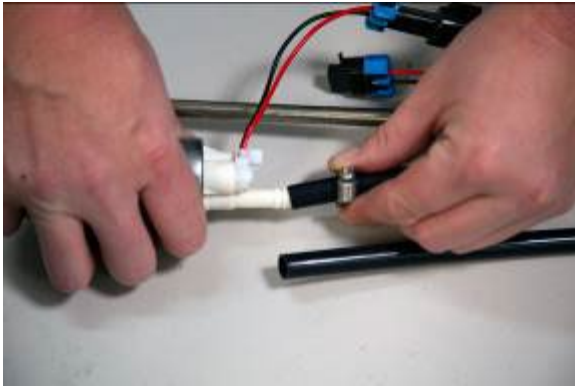

13. Using the larger hose clamp attach the fuel pump(s) to the fuel pump separator and tighten. Insert the two set screws into the pump separator and tighten to secure the pumps.

Note: Ensure the outlet of the pump is directly below the outlet port on the billet outlet cap before tightening all hose clamps so the fuel hose is not at an angle or distorted between the billet outlet cap and pump.

Use this position on pump spacer for Auxiliary Pump (Pump #3 if applicable)

Use this position on pump spacer for Auxiliary Pump (Pump #2 if applicable)

Bottom view of pump spacer.

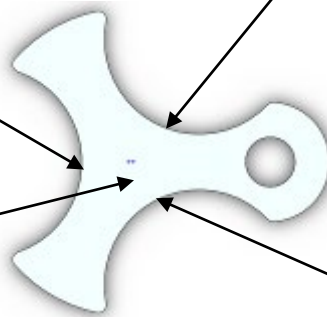

Use this position on pump spacer for Main Pump (Pump #1)



14. Plug the electrical connector(s) into the pump(s) and tuck the wire out of the way.

Note: If using multiple pumps, ensure the correct pump(s) is plugged into the corresponding plug from the outlet cap.

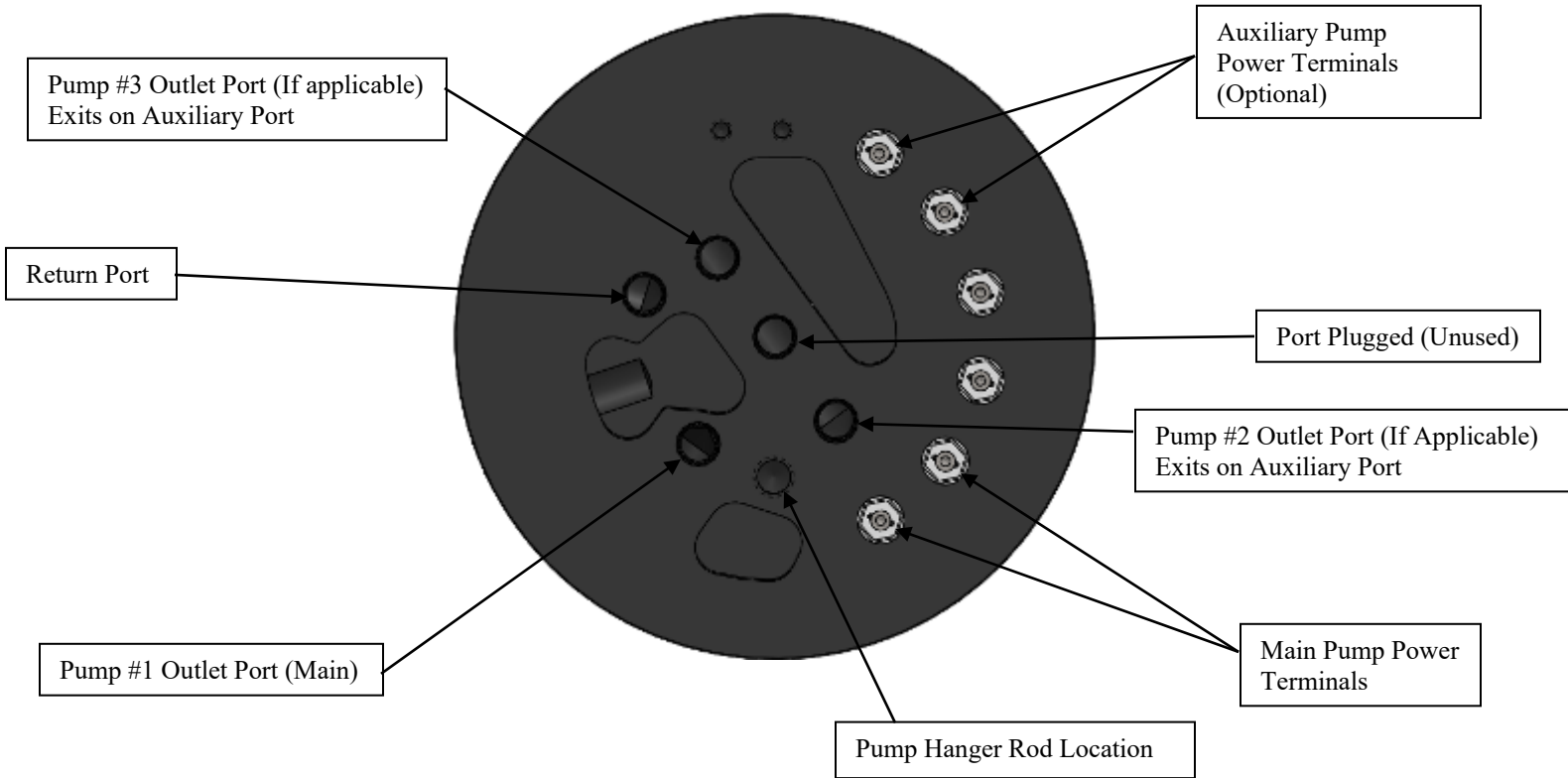

15. Install a new OEM replacement fuel pump gasket (*not included, use AC Delco GM41 or equivalent*) in factory sending unit location. **Note: Do not reuse the existing fuel pump gasket, a new one is required for proper tank seal.**



16. With the fuel pump hanger rod fully assembled and the gasket in place; ease the pump hanger rod assembly into the baffle assembly inside the fuel tank. Rotate the billet fuel pump hanger assembly to orient the fuel line and vent connections in the desired orientation and drop the hanger into the tank.



Caution: Take special care to ensure that the fuel pump wires are fully inside of the tank and will not be pinched in between the pump assembly and the fuel tank during assembly.

17. Press down firmly on the top of the pump assembly to compress the gasket. Position the OEM fuel pump lock ring over the billet fuel pump outlet cap. Rotate the lock ring unit it is firmly seated against the OEM stops. **Ensure the outlet cap and the lock ring are centered with each other and that the gasket is not deformed under the outlet cap flange.**



18. Prep the new tank by making all the necessary connections (feed, return, vent and electrical) before placing tank in vehicle. In most cases, once the tank is placed in the vehicle these connections will not be accessible. For electrical wiring refer to **Figure 2-1**.

Note: Tank vent must be at least 6" above the top of the tank if a roll-over valve is used (highly recommended).

19. Reinstall the fuel tank in the vehicle. In some cases it may be necessary to space the fuel tank down to allow additional clearance for the new pump outlet. Additional fabrication may be necessary to gain clearance in extreme cases.
20. Now route the feed and return line under the vehicle and secure them to the chassis. It's recommended to install a post-filter between the fuel pump and the engine (see Aeromotive part # 12301/12321). Place the filter in a location that is clear of suspension and exhaust system components and easy to get to for servicing.

Note: Be sure to route all fuel lines clear of any moving suspension or drivetrain components, and any exhaust components! Protect fuel lines from abrasion and road obstructions or debris.

21. The pictures below are typical regulator installations for EFI setups with Aeromotive Bypass Regulator P/N 13305. **Figures 1-1 & 1-2**



Fuel Rail with single inlet (Figure 1-1)

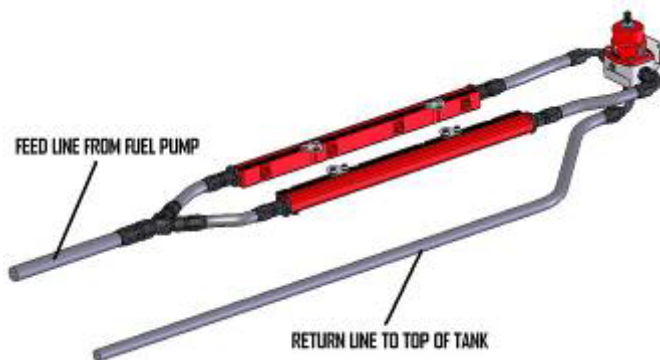

Fuel Rails with inlet/outlets (Figure 1-2)

22. Use the figure below for a single carb installation with Aeromotive Bypass Regulator P/N 13202. **(Figure 1-3)**

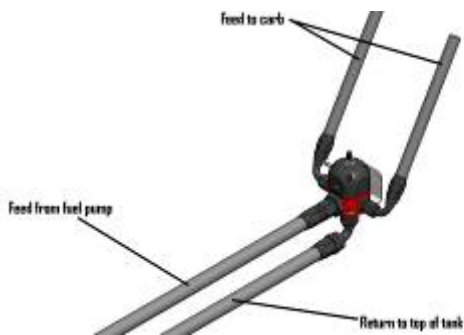

Single carb setup (Figure 1-3)

TRIFEKTA PHANTOM FUEL INJECTED DUAL RAIL

*flywheel	Naturally Aspirated	Forced Induction
GAS	3,300hp	2,400hp
E85	2,250hp	1,650hp



Note: Above diagram shows typical plumbing of a 450 pump Stealth system, outlet cap may not represent outlet cap of this pump assembly.

23. Connect electrical power (12 VDC) to the fuel pump power terminals. Make sure you use stranded, insulated copper wire, in the sizes shown, with matching crimp-type connectors for all connections. **CAUTION: The pump must not be connected directly to the battery.** Connect the Aeromotive fuel pump as shown in the following diagram:
NOTE: ONE RELAY AND FUSE PER PUMP "SIDE" (MAIN OR AUXILIARY TERMINALS).

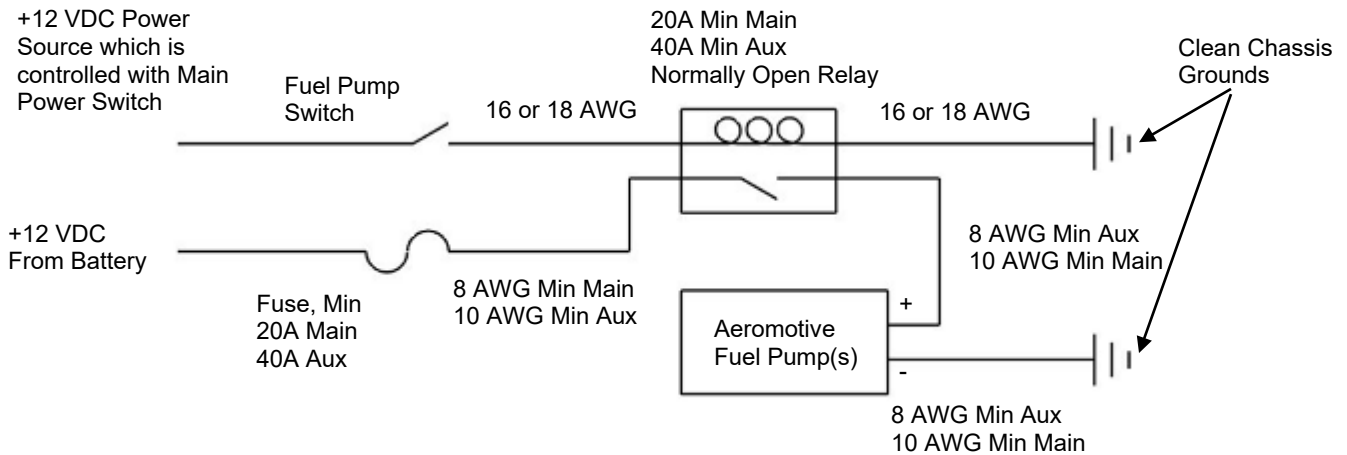

Figure 2-1

CAUTION: While performing the following steps, if any fuel leaks are detected, immediately turn the fuel pump OFF, remove any spilled fuel and repair the leak(s) before proceeding!

- 24. Turn the fuel pump ON **without starting the engine**, allow the pump to run for several seconds and check the fuel pressure. If there is no pressure, turn the fuel pump OFF, wait one minute, then turn the fuel pump ON and recheck the pressure. Repeat this fuel pump OFF and ON procedure until the fuel pressure gauge registers pressure or you detect a fuel leak. It may be necessary to loosen the fuel line fitting at the pressure regulator to bleed off excessive air in the system. Tighten any fuel line fittings which were loosened and ensure that any spilled fuel is cleaned up and removed from the vicinity of the vehicle. If no pressure is registered on the gauge after running the pump for several seconds and you have found no leaks, check all fuel and electrical connections to determine the cause.
- 25. Once the fuel pressure gauge registers pressure, start the engine. The gauge on the fuel pressure regulator should register between 3 and 12 psi for carb and 35-60 for EFI. Now adjust the fuel pressure regulator to the desired setting.

Test drive the vehicle to ensure proper operation and re-check the fuel system for leaks. **If any leaks are found, immediately discontinue use of the vehicle and repair the leak(s)!**

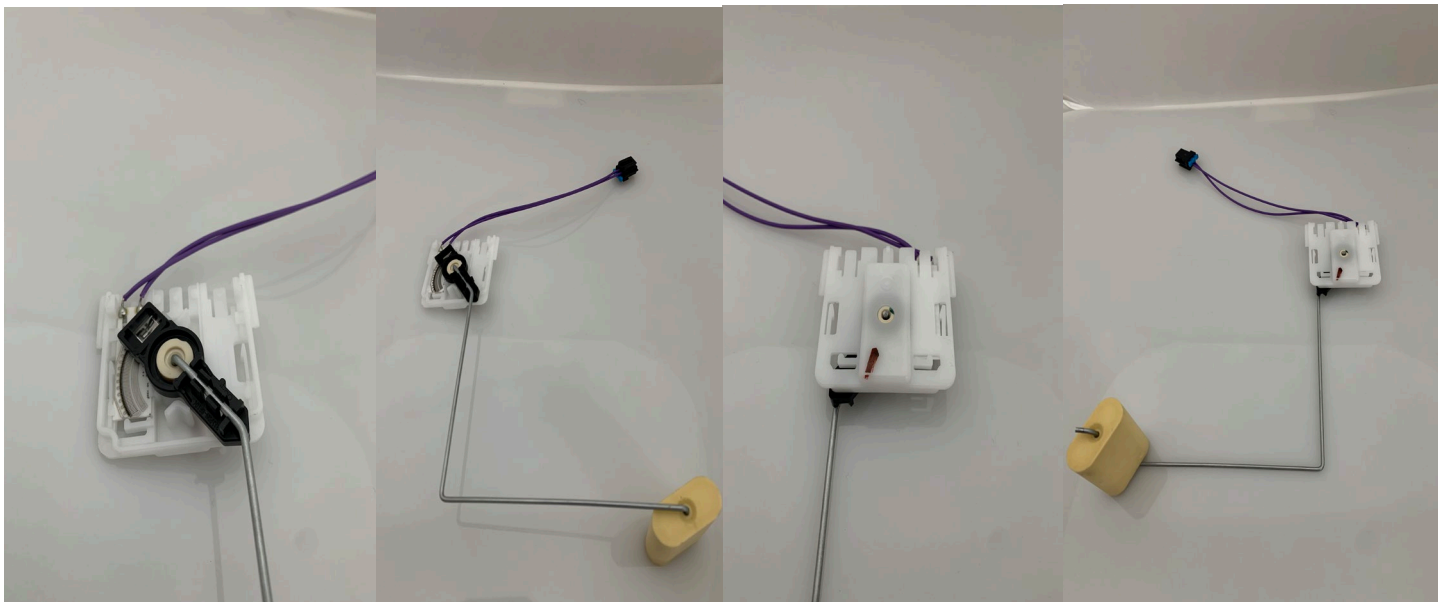

Figure 4-1a

Figure 4-1b

Figure 4-1c

Figure 4-1d

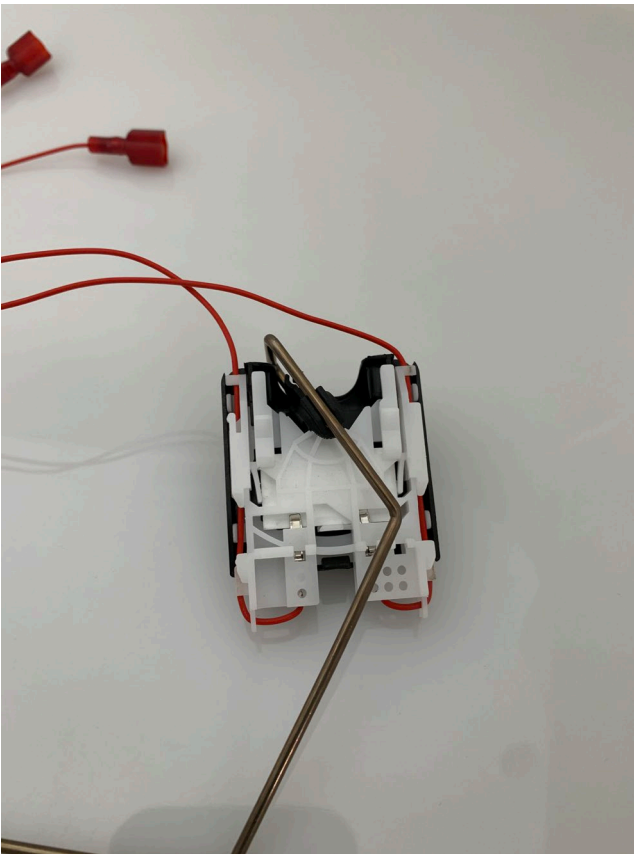

Figure 4-2a

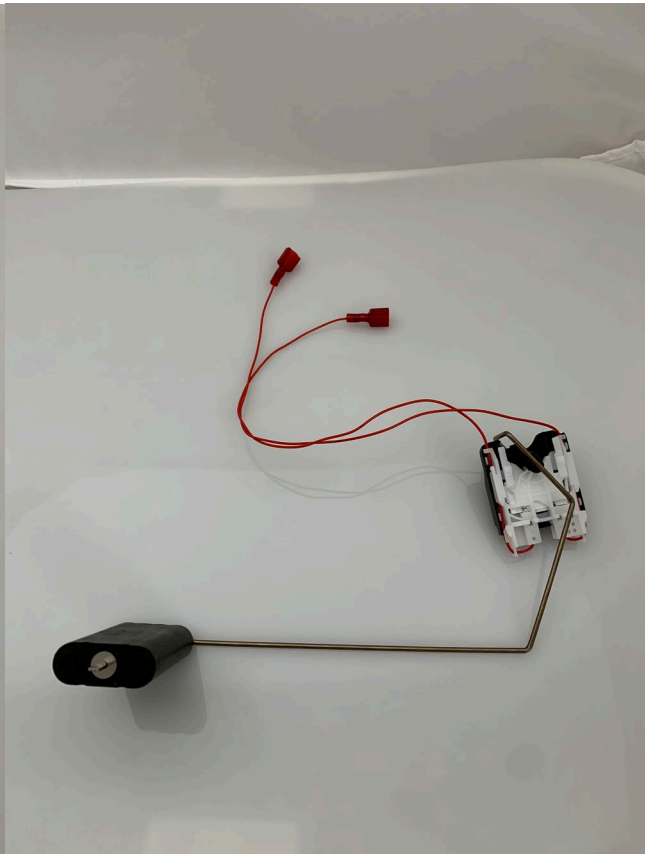

Figure 4-2b



Figure 4-3a

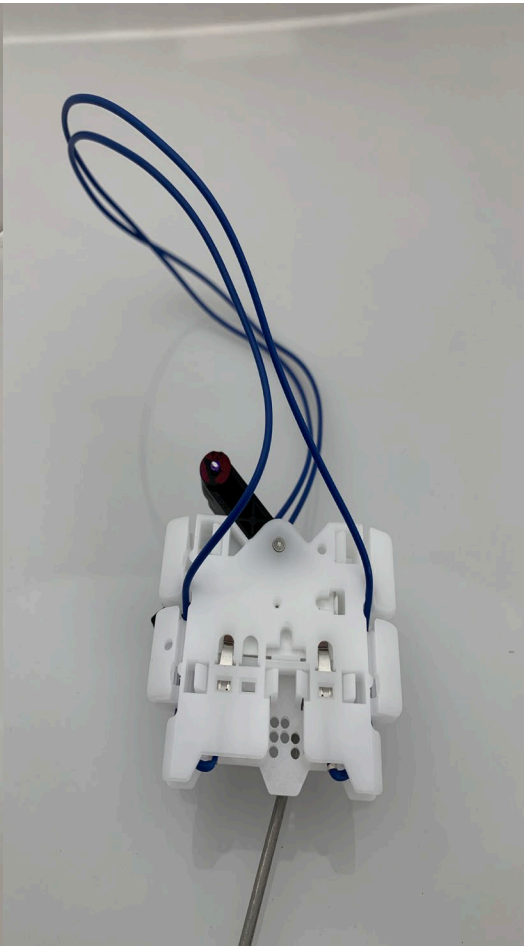

Figure 4-3b



Figure 4-3c

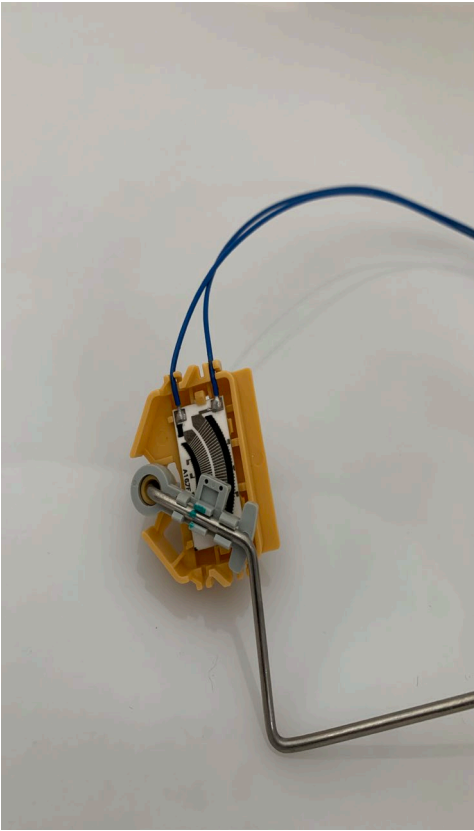

Figure 4-4a

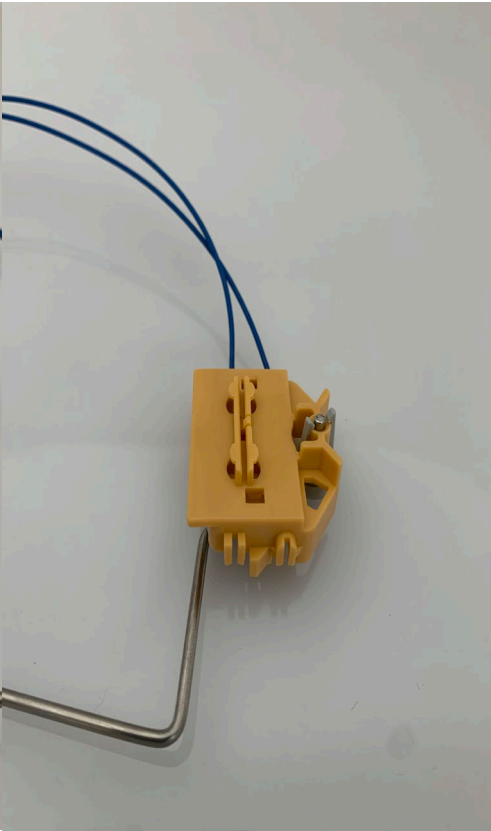

Figure 4-4b

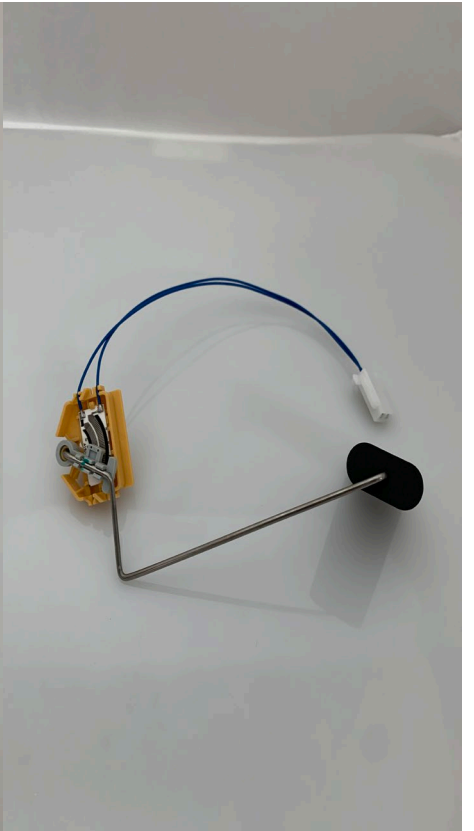

Figure 4-4c

Contact Us

RGA NUMBER REQUIRED FOR ALL RETURNS TO AEROMOTIVE.

To obtain an RGA number, please call (913) 647-7300 and ask for the Returns and Repairs department or complete the online form under the "Rebuilds" section at www.aeromotiveinc.com.

- **Shipping & Returns**

Aeromotive Inc.
10955 Mill Creek Road
Lenexa, KS 66219

General Inquiries and Tech Line: (913) 647-7300

General Email: info@aeromotiveinc.com

Tech Email: tech@aeromotiveinc.com

The Aeromotive Tech Lines are open Monday through Friday from 9:30AM to 5:00PM Central Standard Time.



WARNING: This product can expose you to chemicals, including chromium, which is known to the State of California to cause cancer or birth defects or other reproductive harm. For more information, visit: www.p65Warnings.ca.gov

AEROMOTIVE, INC. LIMITED WARRANTY

This Aeromotive Product, with proof of purchase dated on or after January 1, 2003, is warranted to be free from defects in materials and workmanship for a period of one year from the original date of purchase. No warranty claim will be valid without authentic, dated proof of purchase.

This warranty is to the original retail purchaser and none other and is available directly from Aeromotive and not through any point of distribution or purchase.

If a defect is suspected, the retail purchaser must contact Aeromotive directly to discuss the problem, possible solutions and obtain a Return Goods Authorization (RGA), if deemed necessary by the company. Please call 913-647-7300 and dial option 3 for the technical service dept. All returns must be shipped freight pre-paid to the company and with valid RGA before they will be processed.

Aeromotive will examine any product returned with the proper authorization to determine if the failure resulted from a defect or from abuse, improper installation, misapplication or alteration. Aeromotive will then, at it's sole discretion, return, repair or replace the product.

If any Aeromotive product is determined defective, buyer's exclusive remedy is limited in value to the sale price of the good. In no event shall Aeromotive be liable for incidental or consequential damages.

Aeromotive expressly retains the right to make changes and improvements in any product it manufactures and sells at any time. These changes and improvements may be made without notice at any time and without any obligation to change the catalogs or printed materials.

Aeromotive expressly retains the right to discontinue at any time and without notice any Aeromotive product that it manufactures or sells.

This warranty is limited and expressly limits any implied warranty to one year from the date of the original retail purchase on all Aeromotive products.

No person, party or corporate entity other than Aeromotive shall have the right to: determine whether or not this Limited Warranty is applicable to any Aeromotive product, authorize any action whatsoever under the terms and conditions of this Limited Warranty, assume any obligation or liability of any nature whatsoever on behalf of Aeromotive under the terms and conditions of this Limited Warranty.

This Limited Warranty covers only the product itself and not the cost of installation or removal.

This Limited Warranty is in lieu of and expressly excludes any and all other warranties, expressed or implied. This Limited Warranty gives you specific legal rights, and you may also have other rights which vary from state to state.