



Installation Instructions

718141

2022-2026 Toyota Tundra
With 3.4L Engine
2 or 4-Wheel Drive

Installation requires cutting the OEM exhaust and basic mechanical skill. If this job is beyond your abilities, seek the services of a qualified technician.

If you do not understand any part of these instructions, please call Flowmaster Technical Support at (866) 464-6553 for assistance.

Apply penetrating oil generously to clamps, fasteners, pipes, and hanger rods for ease of disassembly.

REVIEW THE INSTRUCTIONS & VERIFY THE KIT CONTENTS

Take a moment to read and understand these instructions before installing your Flowmaster exhaust kit.

ITEM#	Part #	Description	Qty.
1	70006-603	Muffler Assembly	1
2	MC313BS	3.125" Band Clamp	1

Use the parts drawing and list to verify your kit's contents. In the unlikely event that any parts are missing, please contact Flowmaster Technical Support for replacements.

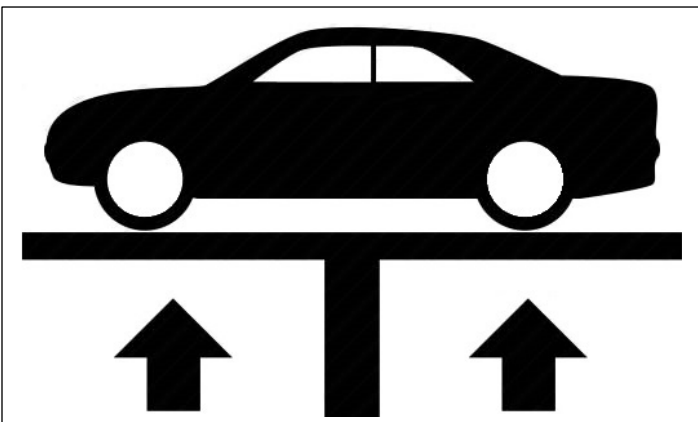
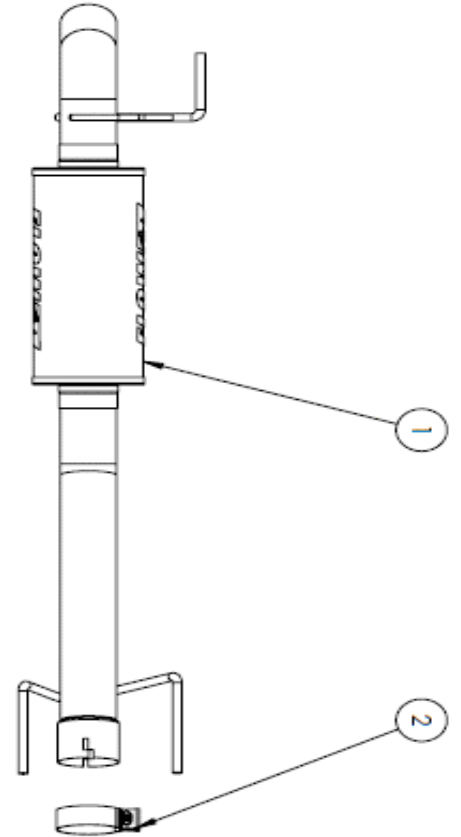

Vehicle Compatibility

Model Year: 2022-2026
Make: Toyota Tundra
Engine: 3.4L V6 Twin Turbo
164.6" Wheelbase
157.7" Wheelbase
145.7" Wheelbase
All trim levels

BEFORE STARTING:

Raise the vehicle a minimum of 18 inches. A floor hoist is ideal. If no hoist is available, we strongly urge the use of axle stands as a safety measure.

Please read and understand these instructions and disclaimer in their entirety before attempting installation.

CAUTION! WORK ONLY ON A SOLID, LEVEL SURFACE. USE JACKS /JACK STANDS OF SUFFICIENT CAPACITY TO LIFT AND SUPPORT YOUR VEHICLE. NEVER WORK UNDER A VEHICLE SUPPORTED BY A FLOOR OR BUMPER JACK.

Removing the OEM Exhaust. “Cutting the OEM Exhaust is Required”

1. Cut the OEM exhaust 1” from the weld on the factory Y-pipe just before the muffler assembly and support the Y-pipe. **Fig.1**

NOTE: This dimension will be the same regardless of the vehicle wheelbase.

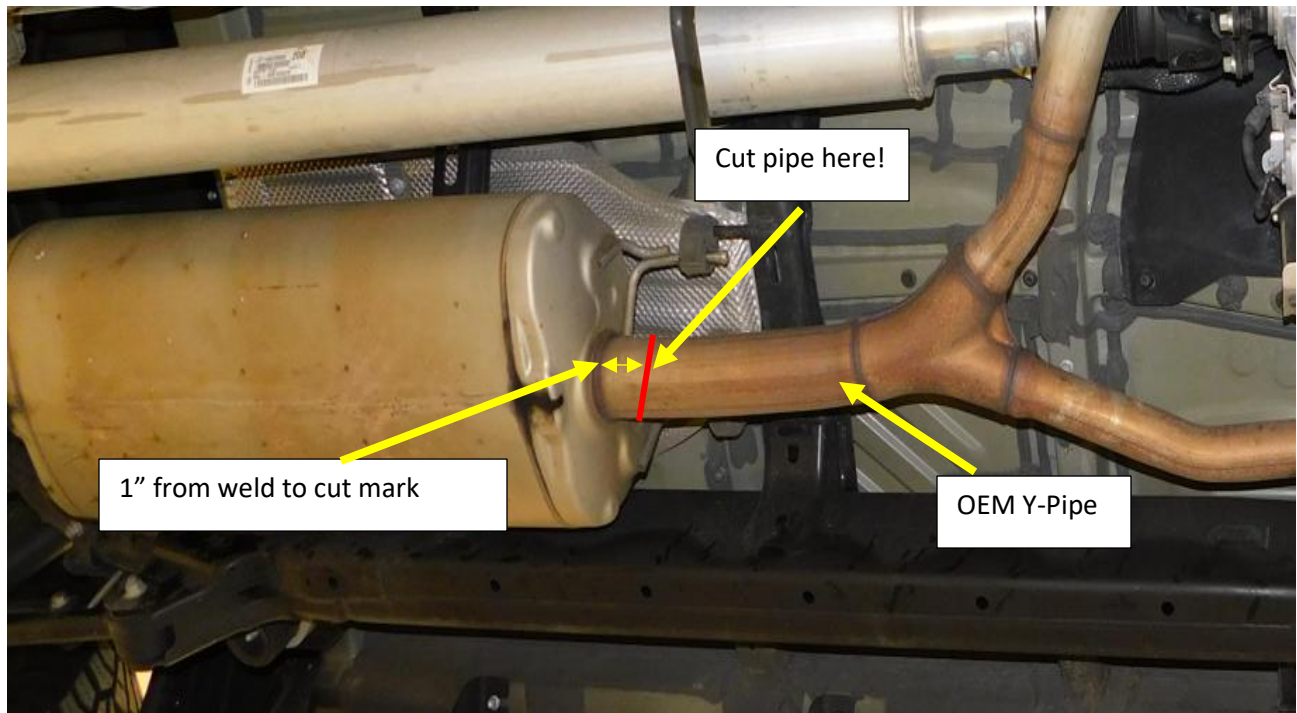

Figure 1

2. Deburr the remaining pipe where it was cut inside and out using a rotary or hand file.
3. Remove the muffler and tailpipe by first removing the tailpipe section at the flange, then remove the muffler. The Y-pipe will remain on the vehicle.
NOTE: It may be necessary to lower the spare tire to remove the tailpipe.
4. Remove the (x2) muffler hanger isolators and the tailpipe isolator (x1) before the rear axle and set aside for re-use.
5. Remove the remaining tailpipe isolators.

INSTALL YOUR FLOWMASTER EXHAUST SYSTEM



Before installing clamps in the following steps, remove their nuts, apply anti-seize compound to the bolt threads, and re-install the nuts.

1. Install the supplied MC313BS band clamp **(2)** on to the expanded inlet of the 718141 muffler assembly **(1)** . **Fig.2**
2. Install the muffler assembly **(1)** onto the OEM Y-pipe until the pipe is fully inserted into the slip joint. **Make sure the assembly is supported.**
3. Apply spray lube to the **(x2)** rubber muffler and **(x1)** tailpipe isolators.
4. Reinstall the rubber muffler hanger isolators and tailpipe isolator on to the muffler assembly **Fig.2**
5. Install the rubber isolators on to the vehicle hanger rods. **(HA1), (HA2), (HA3)**.
6. Check for proper alignment and tighten the MC313BS band clamp **(2)**.

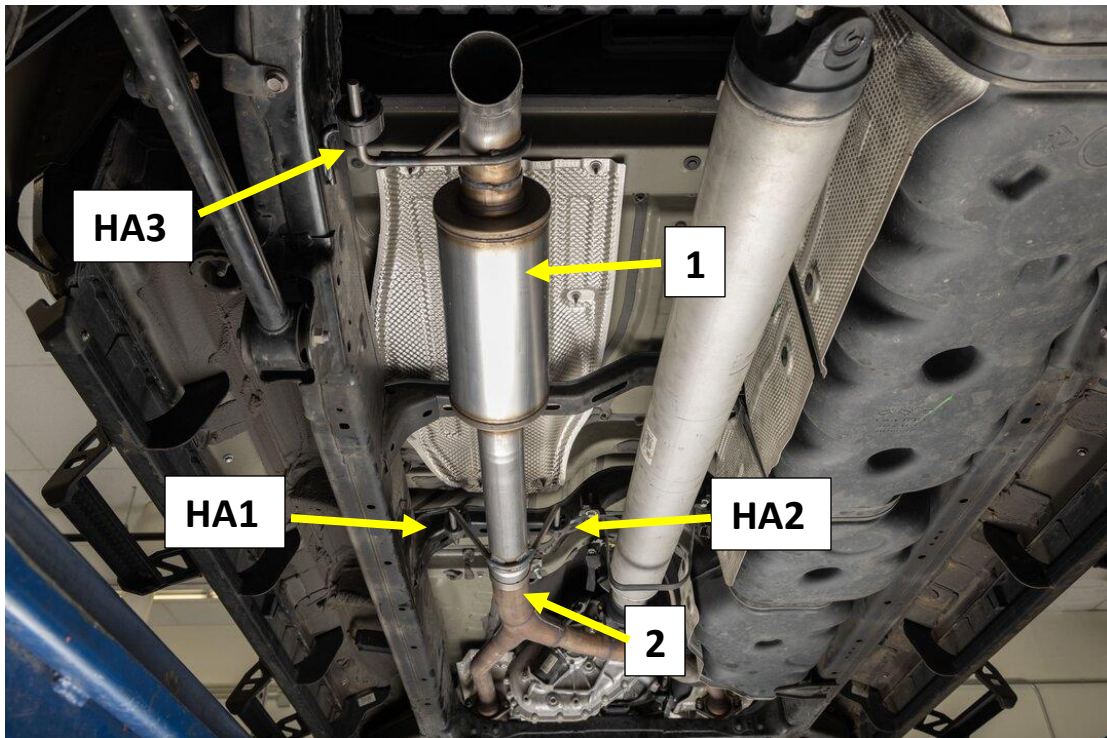

Figure 2

Enjoy Your FlowFX Exhaust!