



Installation Instructions

Part No. 3916789

Competition/Plus® Shifter

Rev 03/25/2020

WORK SAFELY! For maximum safety, perform this installation on a clean, level surface and with the engine turned off. Place blocks or wedges in front of and behind both rear wheels to prevent movement in either direction.

CAUTION: To avoid any possibility of bodily injury or damage to vehicle, do not attempt installation until you are confident that the vehicle is safely secured and will not move.

IMPORTANT

The bolts that fasten the stick to the shifter and the bolts that are used as gear stops are SAE grade 5 bolts. **NOTE:** If bolts need to be replaced, make sure bolts are SAE grade 5. The stiffener plate (Pt. 195 0053) is used with all shifters except those which have tapped holes. Both methods are shown below.

Serration of stick mesh with serrations in shifter mount.

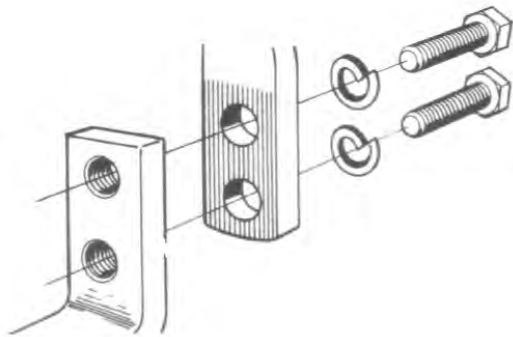

Stick bottom with tapped holes do not require stiffener plate.

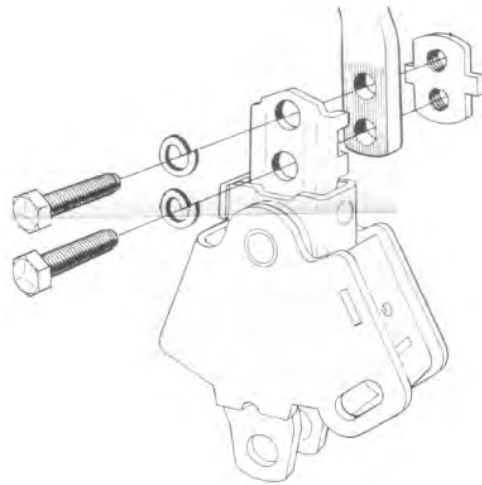

Standard stick configuration require the use of stiffener plate (Pt. 195 0053).

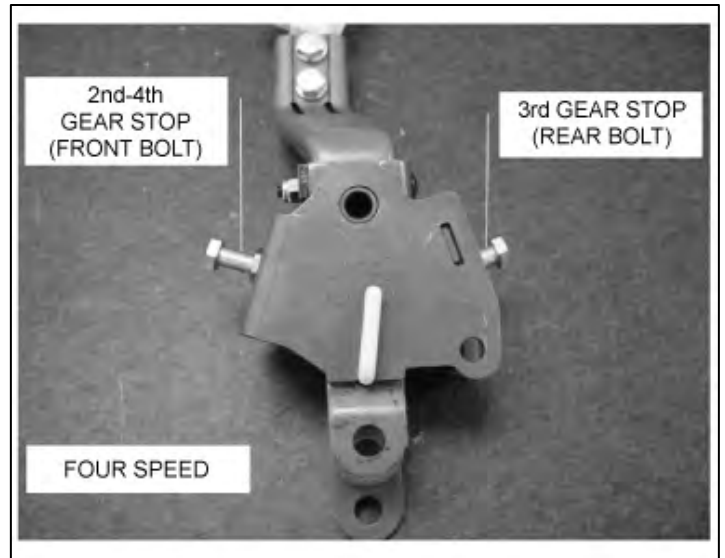

IMPORTANT: RETAIN THESE INSTRUCTIONS FOR FUTURE REFERENCE

Technical Service

Hurst Performance maintains a highly trained technical service department to answer your technical questions, provide additional product information and offer various recommendations.



Hurst Performance Products

(866) 464-6553

www.hurst-shifters.com