



# Installation Instructions

## 818167

2023-2026

Chevrolet Colorado/GMC Canyon

2.7L Turbo Engine



Installation requires moderate mechanical skill. If this job is beyond your abilities, seek the services of a qualified technician.

If you do not understand any part of these instructions, please call Flowmaster Technical Support at (866) 464-6553 for assistance.

Apply penetrating oil generously to clamps, fasteners, pipes, and hanger rods for ease of disassembly.

### REVIEW THE INSTRUCTIONS & VERIFY THE KIT CONTENTS

Take a moment to read and understand these instructions before installing your Flowmaster exhaust kit.

ITM#	Part #	Description	Qty.
1	36088S	Inlet Pipe	1
2	8535502-Z	Muffler	1
3	86765S	Right Tail Pipe	1
4	86768S	Left Tail Pipe A	1
5	86769S	Left Tail Pipe B	1
6	ST461	Tip 2.5" x 3.5" x 13" L	2
7	86766S	Side Exit Pipe	2
8	86767S	Rear Exit Pipe	2
9	536HA	Frame Hanger	1
10	HA2276	Frame Hanger Plate	1
11	MC350BS	3.5" band Clamp	1
12	MC250BS	2.5" Band Clamp	5
13	HW505	Cable Tie	3
14	HW220	3/8-16 X4" Bolt	1
15	HW120	3/8-16 NUT	1
16	HW303	3/8 Flat Washer	2
17	HW309	Split Washer	1
18	HA168	Rubber Exhaust Hanger	1
19	HW503	1/2" Push Nut	6
20	HW502	7/16" Push Nut	1

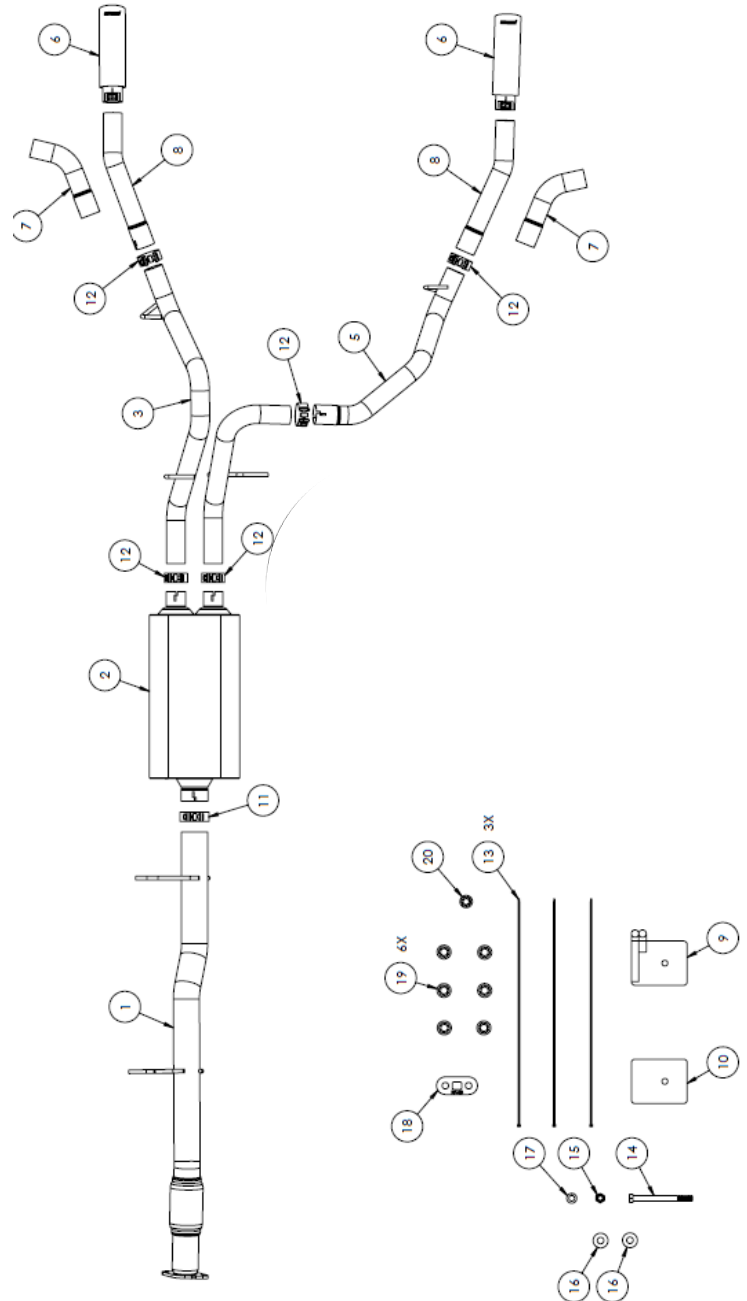

Use the parts drawing and list to identify components and verify your kit's contents. In the unlikely event that any parts are missing, please contact Flowmaster Technical Support for replacements.

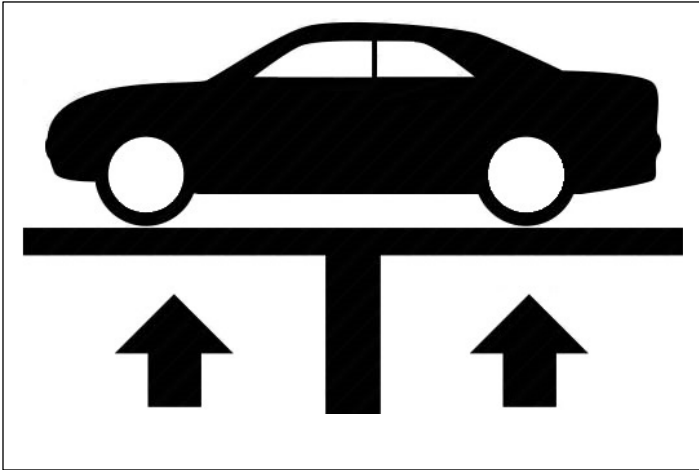

## Vehicle Compatibility

Model Year: 2023-2025

Make: Chevrolet Colorado/ GMC Canyon

Engine: 2.7L Turbo

- Two Wheel Drive and Four-Wheel Drive
- Side exit and Rear exit tail pipe configurations are included.

### BEFORE STARTING:

Raise the vehicle to a minimum of eighteen inches. A floor hoist is ideal. If no hoist is available, we strongly urge the use of axle stands as a safety measure. **Please read and understand these instructions and disclaimer in their entirety before attempting installation.**

**CAUTION! WORK ONLY ON A LEVEL SURFACE. USE JACKS /JACK STANDS OF SUFFICIENT CAPACITY TO LIFT AND SUPPORT YOUR VEHICLE. NEVER WORK UNDER A VEHICLE SUPPORTED BY A FLOOR OR BUMPER JACK.**

---

### Removing the OEM Exhaust:

**NOTE: Cutting the Factory exhaust for removal is recommended but not necessary. Removing the factory exhaust can be done as one piece. (See exhaust removal special note)**

**Please read and follow all instructions before attempting to install this exhaust system.**

## Removing the OEM Exhaust:

1. Apply penetrating oil to each rubber hanger on the exhaust.
2. Remove the (x2) 15mm nuts at the two-bolt flange connection. **Fig.1**
3. Cut the exhaust pipe just before the muffler with a reciprocating saw. **Fig.1**
4. Remove the (5) rubber Isolators from the hanger rods
5. Remove the exhaust from the vehicle in two sections.

### Special Note: Removing the exhaust without cutting.

A lift is needed to raise the vehicle. Remove the spare tire and heat shield. Remove the nuts at the 2-bolt flange, remove the rubber hanger isolators. With the rear suspension fully extended the entire exhaust assembly can be pushed back over the rear axle and rotated far enough to get the front flange past the cross member. Drop the front of the exhaust and remove the assembly towards the front of the vehicle until the tail pipe clears the rear axle.

**Caution:** Be very careful not to damage the drive shaft while removing the exhaust.

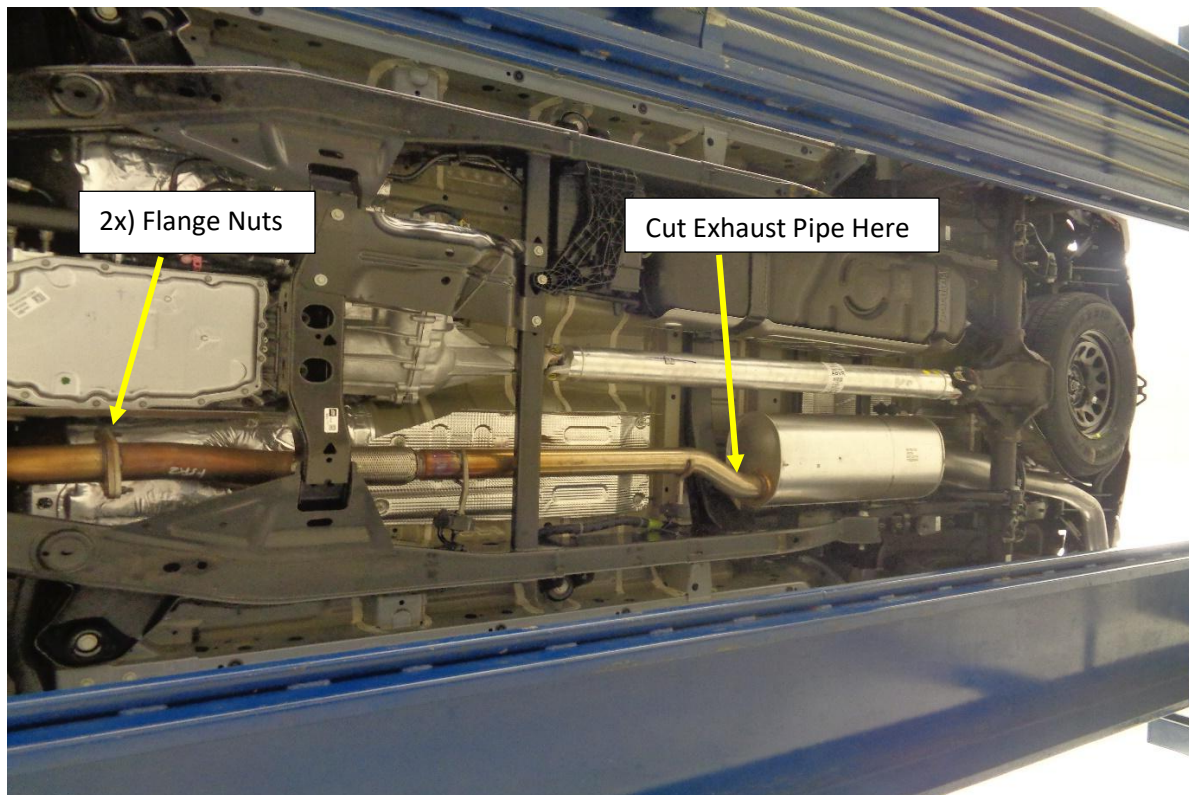

Figure.1

## INSTALL YOUR FLOWMASTER EXHAUST SYSTEM



Before installing clamps in the following steps, remove their nuts, apply anti-seize compound to the bolt threads, and re-install the nuts.

1. Re install the Spare tire heat Shield and the spare tire if they were removed.
2. Re install the 5 rubber hanger rod isolators on to the vehicle if they are removed.
3. Install the Flowmaster Muffler inlet pipe **(1)** into the vehicle and on to the studs at the catalytic converter 2 bolt flange. **Fig.2**
4. Install the hanger rods into the isolators. **Fig.2**
5. Install the (2x) 15mm nuts on to the studs at the 2 bolt flange. **Fig.2**

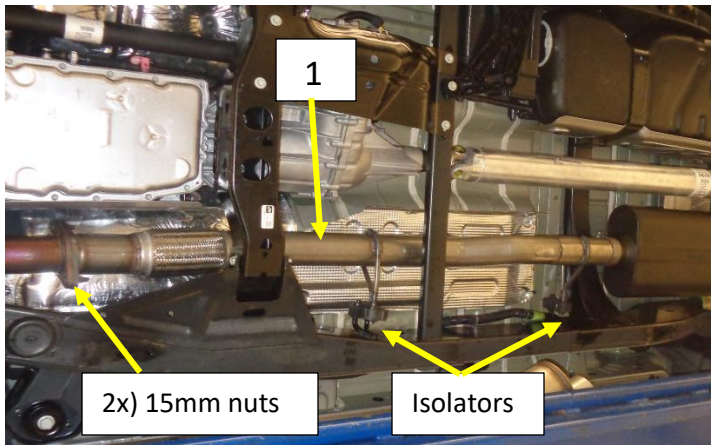

**Figure.2**

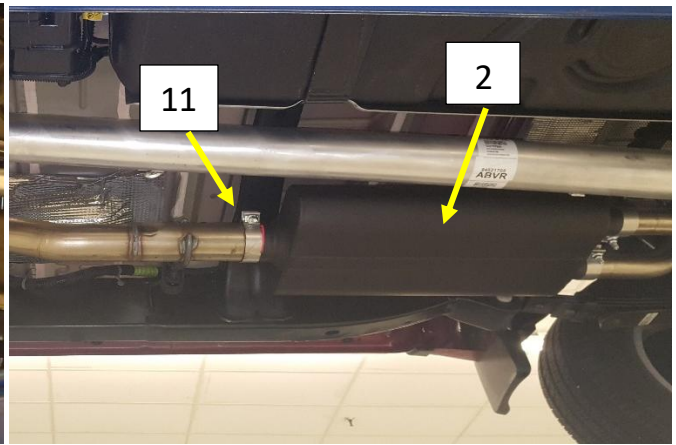

**Figure.3**

6. Install a supplied 3.5" band clamp **(11)** on to the Muffler inlet, Bolt at the top of the muffler and the nut facing the drive shaft. **Fig.3**
7. Install the muffler **(2)** on to the muffler inlet pipe and level with the ground, Tighten the clamp to allow for adjustment. Support the Muffler with a jack stand. **Fig.3**

## Installation Exhaust Continued

8. Install (x2) Supplied 2.5" band clamps (12) on to the muffler outlet pipes as shown. Do not tighten Fig.4
9. Install the right Tail pipe (3) and Left tail pipe A (4) into the muffler outlet. Install the hanger rod into the isolator over the muffler and the Right rear tail pipe hanger rod into the isolator just past the axle Fig.5

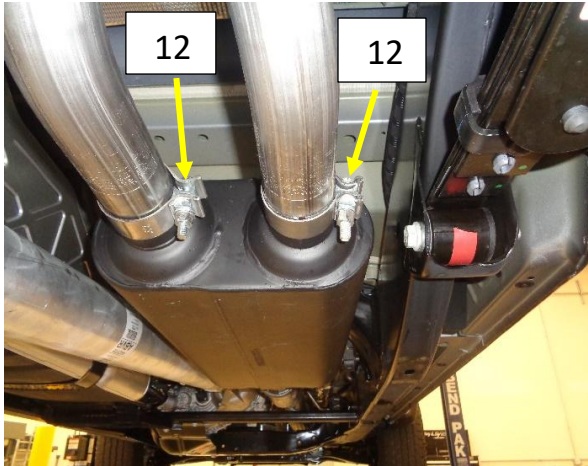

Figure.4

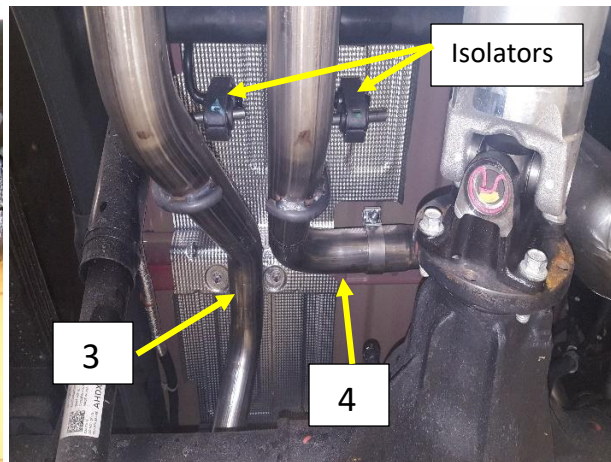

Figure.5

10. Locate the large round hole in the left frame rail just behind the shock. Fig. 6
11. Install the supplied Frame hanger assembly (9) at that location using the supplied 3/8" X 4" bolt (14), flat washers (16), lock washer, Nut (15) and Backing plate (10). Fig.7
12. Center the frame hanger assembly over the hole and up against the weld on the rear crossmember. Fig.7
13. Install the 4" (14) bolt with flat washer (16) into the backing plate (10) and install the bolt through the frame into the frame hanger assembly (9). Install a flat washer (16), Split washer (17) and nut (15) then tighten. Fig.7

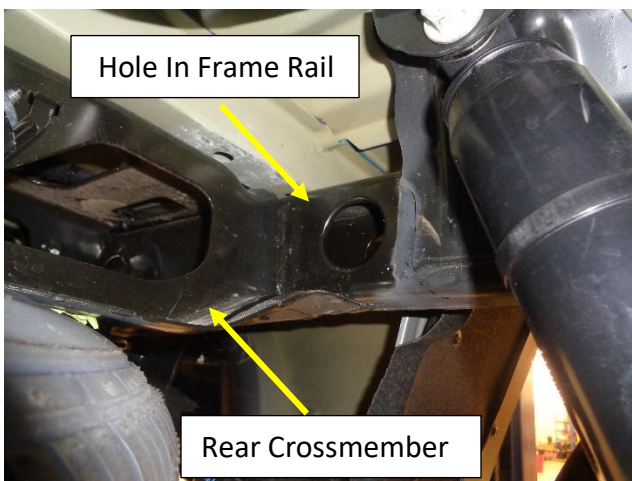

Figure.6

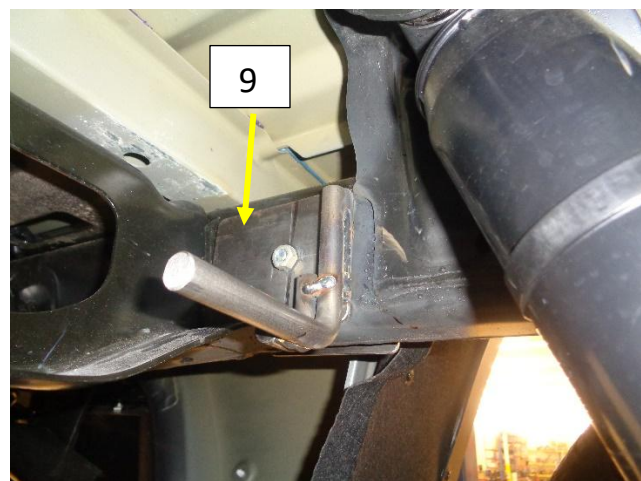

Figure.7

## Installation Exhaust Continued

14. Use the supplied Cable ties (13) to tie back the ABS cables to the brake hose as shown in Fig.8, Fig.9, Fig.10 and Fig.11

**Attention:** The ABS harness should still be able to float with the rear suspension movement after the cable ties are installed.

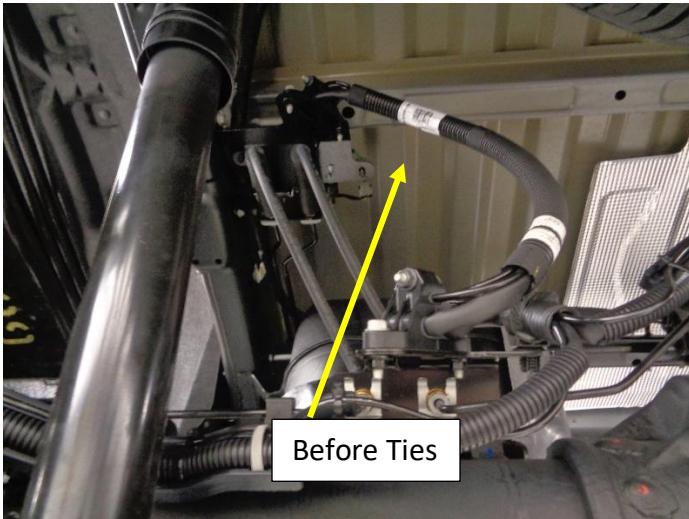

Figure.8

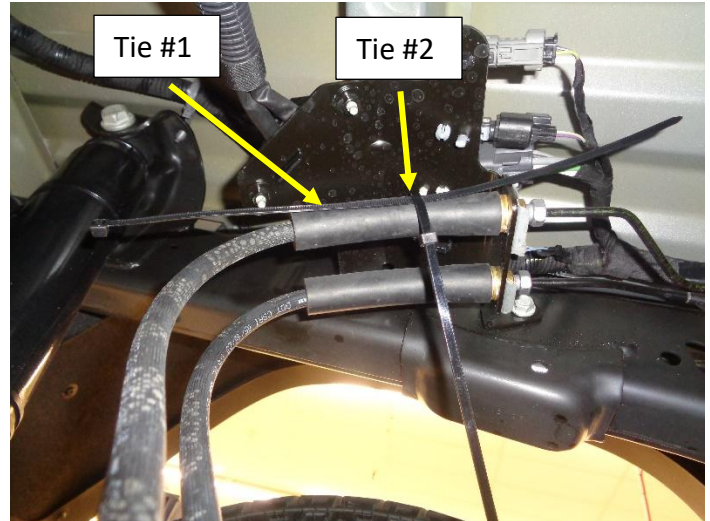

Figure.9

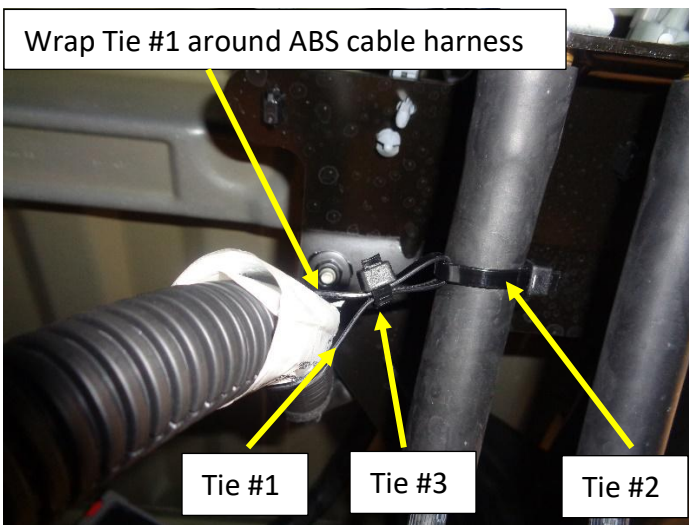

Figure.10

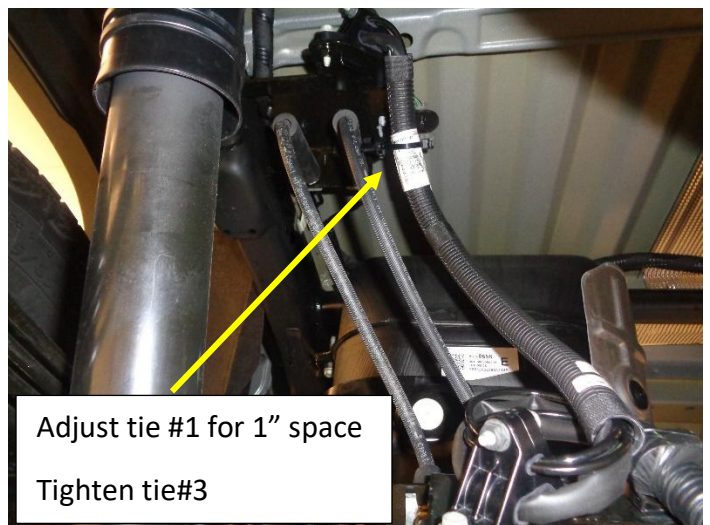

Figure.11

## Installation Exhaust Continued

15. Install a 2.5" band clamp (12) on to the expanded end of the left tail pipe B (5). Position the clamp with the bolt at the top of the pipe and the nut facing the Drive shaft. Fig.12
16. Install the left tail pipe B (5) on to the tail pipe A above the rear axle. Fig.12 /Fig.13
17. Install the supplied Red Isolator on to the Frame hanger assembly.
18. Install the tail pipe rear hanger rod into the Isolator at the frame hanger (9) Fig.14

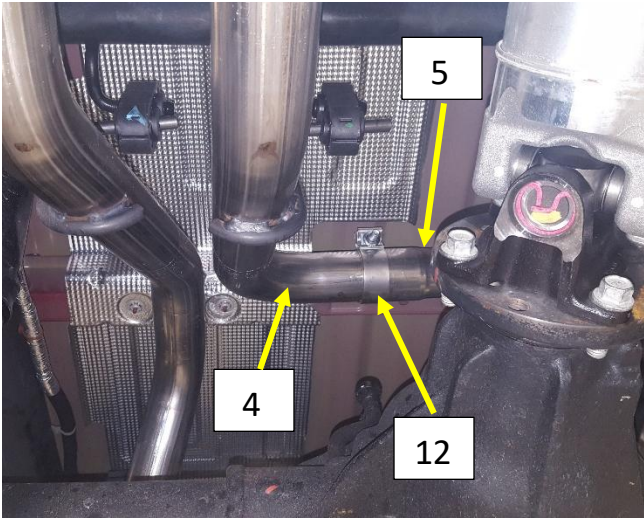

Figure.12

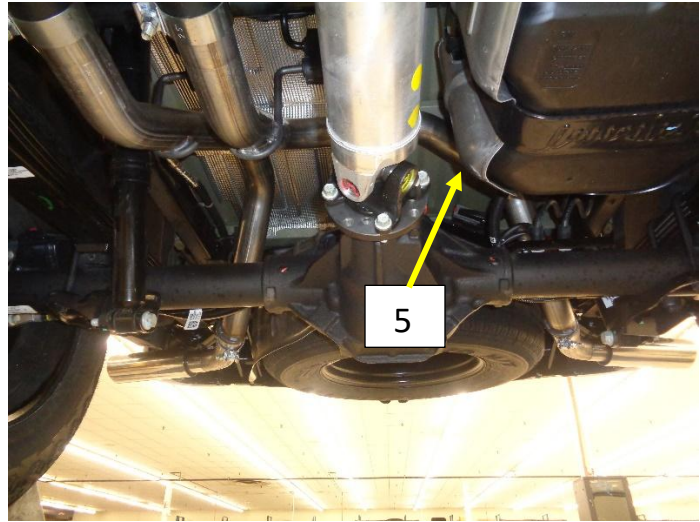

Figure.13

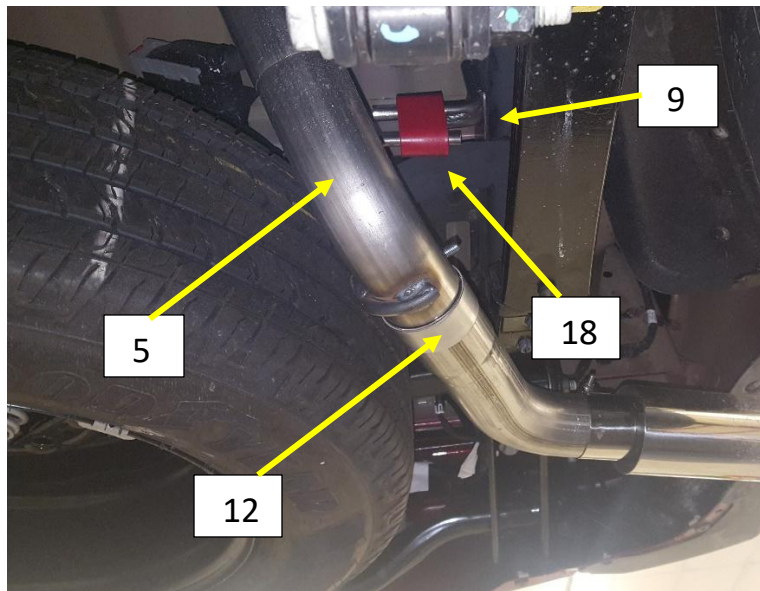

Figure. 14

## Installation Exhaust Continued

19. Install a supplied 2.5" band clamp (12) onto either the Side Exit Pipe (7) or the Rear exit Pipe (8).
20. Install the exit pipe on to the right and left tail pipe and tighten the clamp to allow for adjustment.
21. Install the supplied exhaust tip (6) on to the exit pipe, adjust to desired position and tighten the clamp bolt.

**Note: Loosen the spare tire and push the tire as far to the passenger side as it will go to gain clearance for the left tail pipe.**

22. Start at the front of the vehicle and adjust the system for best alignment and clearance. Tighten the clamps as you go. Make final adjustments and re torque the clamps and check all fasteners after the first test drive.
23. Install the Push Clips on to the hanger rods to prevent the system from moving.

**Note: The left rear hanger rod uses the 7/16" push Clips (20).  
All other rods will use the 1/2" push clips (19)**



## Enjoy Your Flowmaster Exhaust!

