

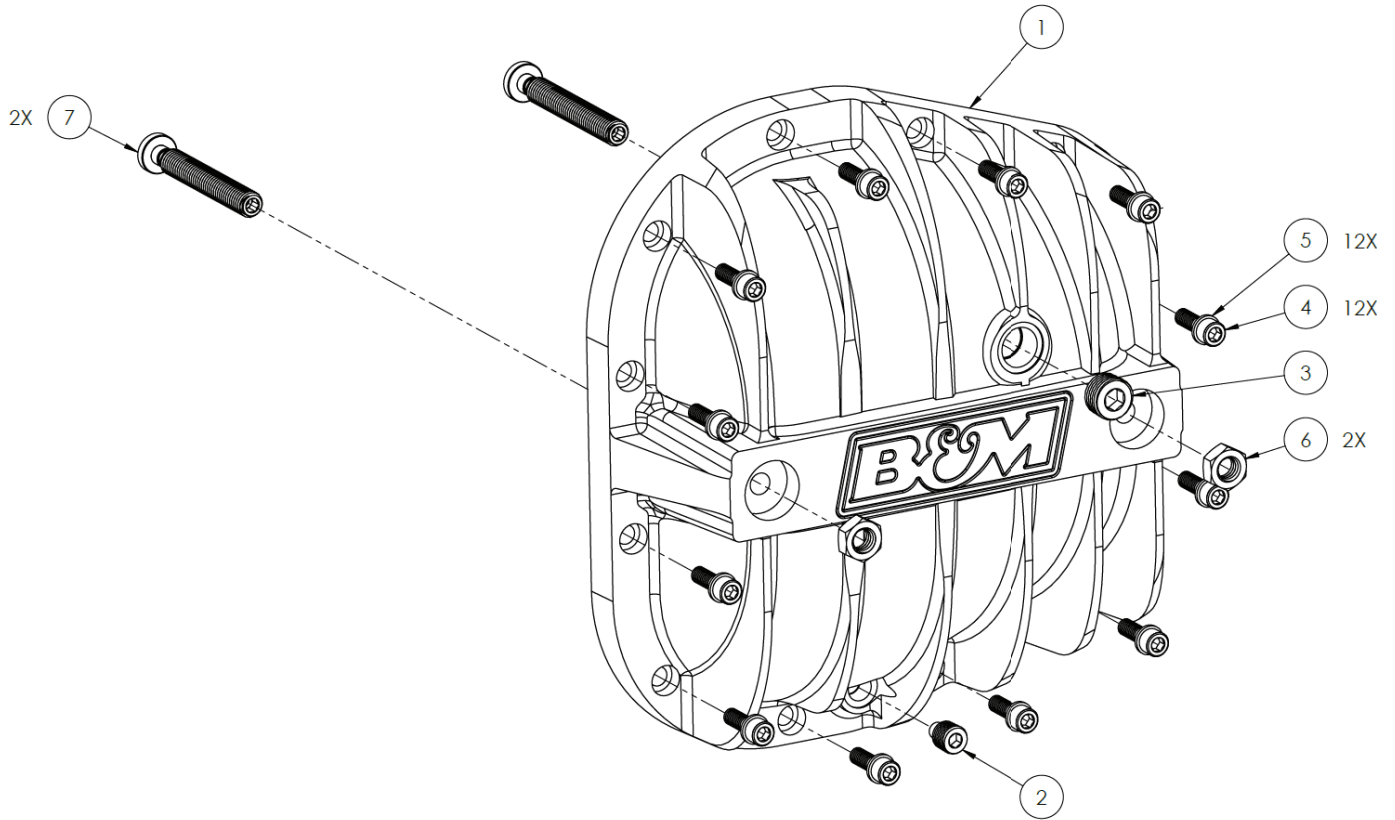

Installation Instructions
40298 & 41298
CAST ALUMINUM DIFFERENTIAL
COVER
FORD 9.75" REAR

For specific vehicles, see "Applications" tab on this products web page.



ITEM	PART NO.	DESCRIPTION	QTY.
1	2000266	DIFF COVER, FORD 9.75", NATURAL	1
	2000287	DIFF COVER, FORD 9.75", BLACK	1
2	3401482	DRAIN PLUG, MAGNETIC, 1/4" NPT	1
3	3400407	FILL PLUG, 1/2" NPT	1
4	3401009	CAP SCREW, 5/16-18 × 1"	12
5	3401479	WASHER, 5/16"	12
6	3401478	JAM NUT, 1/2-13	2
7	3401493	LOAD SCREW, 1/2-13 × 3-3/4"	2

PRODUCT FEATURES AND BENEFITS

- Thick, cast aluminum construction increases case rigidity.
- Reinforced center bar and load screws prevent bearing cap deflection under severe loads.
- Increased oil capacity for cooler operation.
- Magnetic drain plug allows regular gear oil changes without the usual mess, and captures ferrous wear metal.

INTRODUCTION

Please read and understand these instructions before installing your B&M differential cover. Installation takes about an hour.

Use the parts list to verify your kit's contents. In the unlikely event that any parts are missing, please contact B&M Technical Support for replacements.

WORK SAFELY! Perform the installation on a clean, level surface, with the vehicle's engine turned off, the parking brake engaged, and the transmission in PARK (if automatic) or first gear (if manual). Allow the vehicle to cool off sufficiently to avoid burns from hot parts and oil. Use jack stands, wheel ramps or a hoist to raise the vehicle 1-2 feet for ease of access. **MAKE SURE THE VEHICLE IS FIRMLY SUPPORTED! NEVER WORK UNDER ANY VEHICLE SUPPORTED ONLY BY A JACK!** Also, have a suitable drain pan, and a small box in which to keep removed hardware.

CAUTION: To avoid any possibility of bodily injury or damage to vehicle, do not attempt installation until you are certain that the vehicle is securely supported and will not move.

REQUIRED TOOLS AND MATERIALS

- | | |
|--|---|
| <input type="checkbox"/> Jack and jack stands | <input type="checkbox"/> Gasket scraper |
| <input type="checkbox"/> Drain pan | <input type="checkbox"/> Flat head screwdriver |
| <input type="checkbox"/> Lint-free rags | <input type="checkbox"/> Disposable (fiber or cork) gasket (optional) |
| <input type="checkbox"/> Brake cleaner | <input type="checkbox"/> RTV silicone sealant (gear oil-compatible) |
| <input type="checkbox"/> 3/8" ratchet and 3" extension | <input type="checkbox"/> PTFE thread tape |
| <input type="checkbox"/> 1/2" and 3/4" sockets | <input type="checkbox"/> Gear oil pump |
| <input type="checkbox"/> 1/4" and 3/8" Allen bits | <input type="checkbox"/> Gear oil (per manufacturer's specification) |
| <input type="checkbox"/> Torque wrench | |

INSTALLATION

1. To avoid contaminating the differential, clean dirt and debris from the area around the cover.
2. Place a drain pan under the differential housing.
3. Remove all differential cover screws except one at the top. Then loosen (but do not remove) the top screw.
4. Carefully pry the cover loose with a flat head screw driver, using caution to avoid damaging the housing flange. Allow the oil to drain.

CAUTION: If your differential has a reusable (aluminum and rubber) gasket, take care not to damage it.

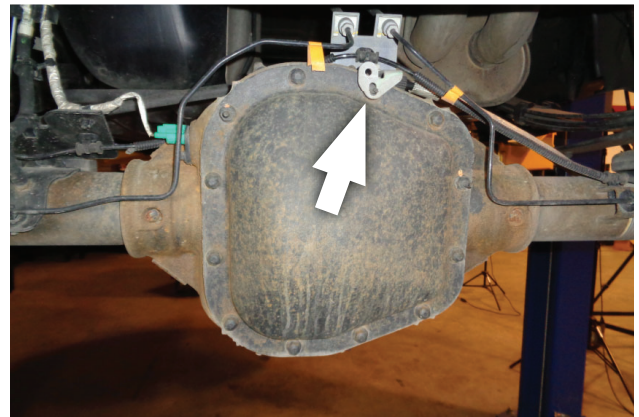

NOTE: On some vehicles, access to the cover may be made easier by loosening / removing surrounding parts (sway bar, brake line bracket, Panhard rod, etc.).

5. When the oil has finished draining, remove the top screw and the cover. **Inspect oil for metal particles, which may indicate worn gears or bearings.**

6. Using brake cleaner and a lint-free rag, clean the internal components. **Inspect differential components for broken gear teeth, excessive wear, etc.**



7. IF YOUR DIFFERENTIAL HAS A REUSABLE GASKET, carefully remove, clean, and inspect it for usability.

8. IF YOUR DIFFERENTIAL USED A DISPOSABLE GASKET OR RTV SILICONE, use a gasket scraper and brake cleaner to remove all the old gasket material from the axle housing flange.

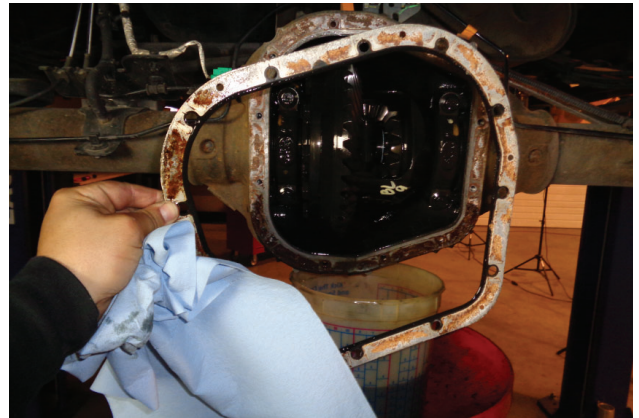

9. Install the 2 supplied load screws all the way into their holes from the inside of the B&M differential cover.

10. IF USING A GASKET (RECOMMENDED): Place the gasket on the cover's flange. Go to Step 12.

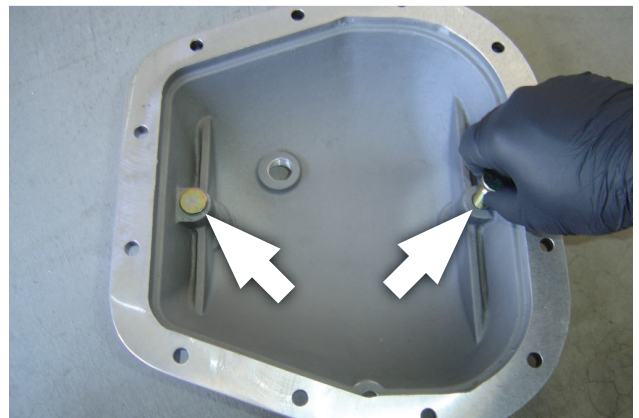

11. IF USING RTV SEALANT: Apply a continuous bead of gear oil-compatible RTV silicone sealant to the cover's flange. **Run the sealant between the screw holes and the inside edge of the flange.**

NOTE: Follow the sealant manufacturer's instructions re. use of the sealant (e.g., screw tightening procedure, cure time, etc.).

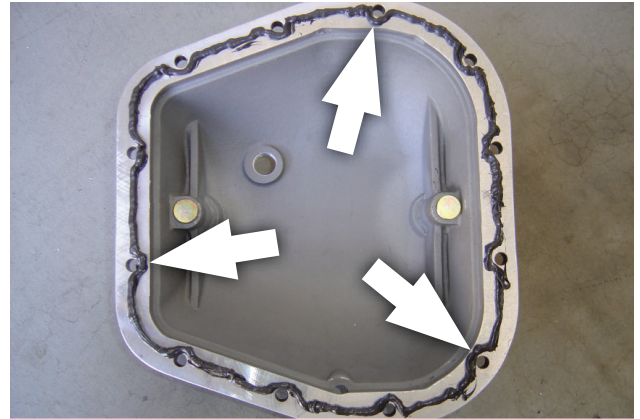

12. Install the cover on the differential housing using the 12 supplied screws and washers. Tighten the screws in an alternating or "criss-cross" pattern to 15 ft-lbs torque.
13. Use an Allen bit socket to run the two load screws in by hand until they touch the bearing caps. Then tighten the load screws to 5 ft-lbs (or 60 in-lbs) torque.

CAUTION: Do not over-torque the load screws, as this can distort the bearing caps, and cause abnormal differential wear and premature failure.

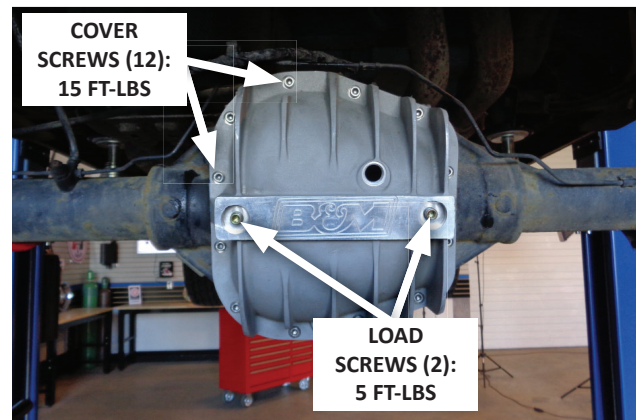

14. Apply a small amount of RTV sealant to the exposed threads of the load screws, then install the 2 supplied jam nuts on the load screws. Tighten the jam nuts to 5 ft-lbs (or 60 in-lbs) torque.
15. Apply 2 wraps of PTFE thread tape to the supplied magnetic drain plug, install it in the differential cover, and tighten it to 25-30 ft-lbs torque.

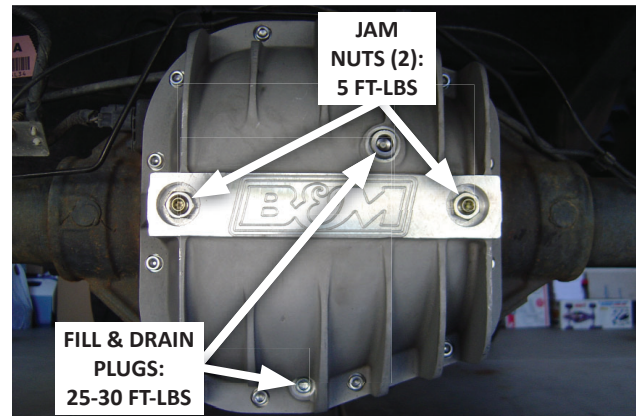

16. Remove the fill plug from the differential case.
17. Fill the differential with manufacturer-specified gear oil until it just overflows the factory fill hole.
18. When the overflow has stopped draining, apply 2 wraps of PTFE thread tape to both the factory fill plug and the supplied cover fill plug. Install and tighten the plugs to 25-30 ft-lbs torque.
19. Reinstall any surrounding parts that may have been removed (sway bar, brake line bracket, Panhard rod, etc.).

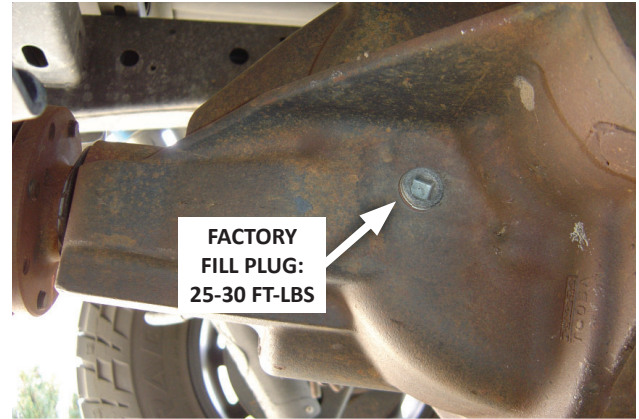

NOTE: Differential manufacturers typically recommend inspecting the oil any time the differential has been submerged in water. See your owner's or maintenance manual for details.

Congratulations, the installation of your B&M differential cover is now complete!

IMPORTANT: Keep these instructions for future reference.

