



DELTA FORCE

PERFORMANCE INTAKES BY FLOWMASTER

Installation Instructions 615111

This kit is not engineered to fit vehicles with a body lift.
SEE CARB APPROVED SPECIFIC APPLICATION INFORMATION AT TOP OF
PAGE 2.



Watch our
installation video
on YouTube

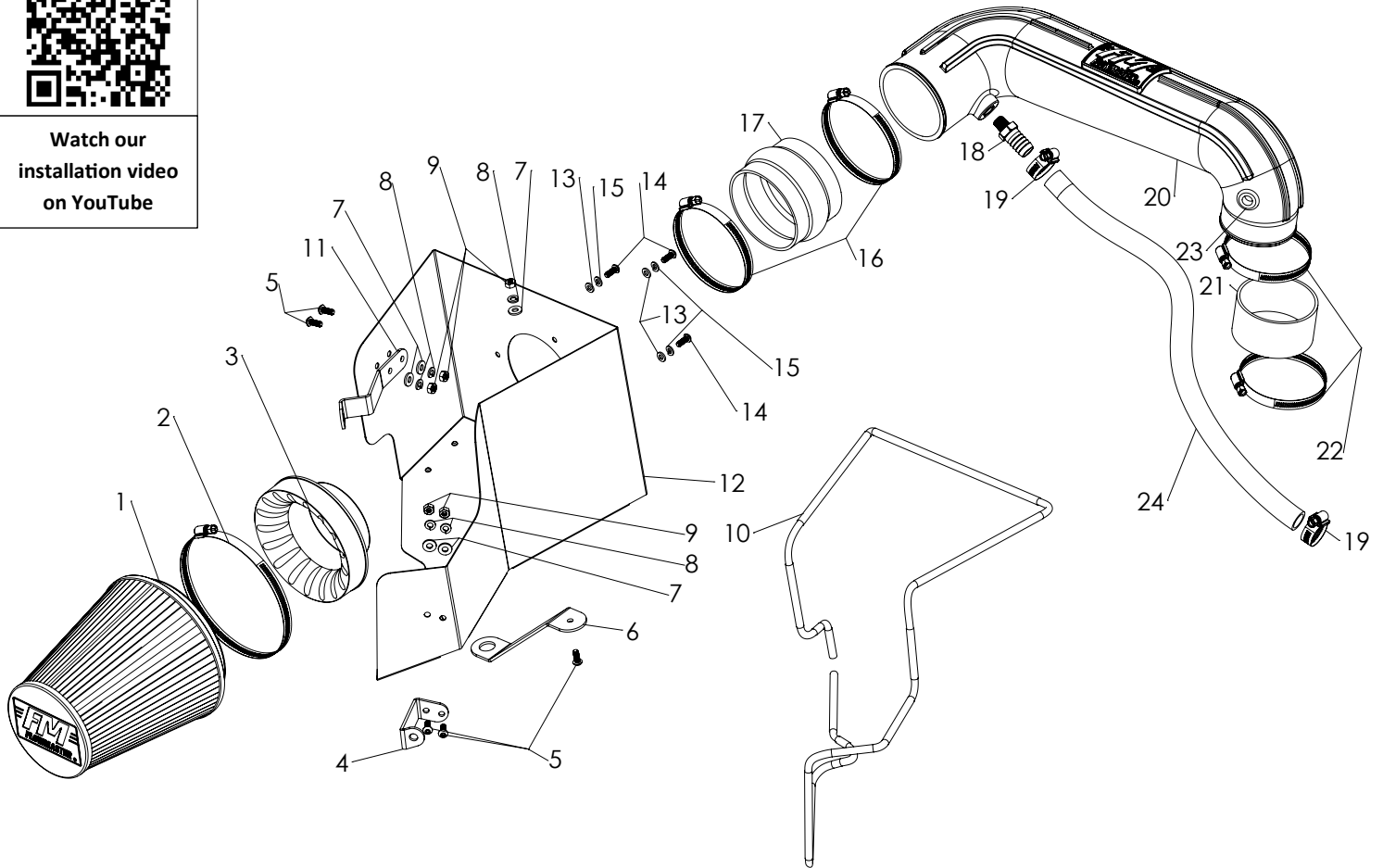

ITEM NO.	PART NUMBER	DESCRIPTION	QTY.
1	AF1001	AIR FILTER, 8-5/8" x 6" DIA	1
2		SCREW CLAMP, #104 (4-1/8" - 7")	1
3	AF6002	ADAPTER, AIR FILTER 4" x 6"	1
4	AF5004	BRACKET 1	1
5	HW245	SCREW, 1/4"-20 x 5/8"	5
6	AF5006	BRACKET 3	1
7	HW320	FLAT WASHER, 1/4"	5
8	HW322	LOCK WASHER, 1/4"	5
9	HW115	NUT, 1/4"-20	5
10	49000061	GASKET, HEAT SHIELD	1
11	AF5005	BRACKET 2	1
12	AF3001	HEAT SHIELD	1
13	HW319	FLAT WASHER, M6	3

ITEM NO.	PART NUMBER	DESCRIPTION	QTY.
14	HW244	SCREW, M6 x 1.0 x 16MM	3
15	HW318	LOCK WASHER, M6	3
16	MC400H	SCREW CLAMP, #64 (3-9/16" - 4-1/2")	2
17	AF4005	COUPLER, FLEX 4" I.D. x 3" L	1
18	AF4013	FITTING, STRAIGHT 3/4" BARB TO 1/4" NPT MALE	1
19	MC125H	SCREW CLAMP, #12 (1/2 - 1-1/4")	2
20	AF2001	INTAKE TUBE	1
21	AF4007	COUPLER, STRAIGHT 3-1/2" I.D. x 2" L	1
22	MC350H	SCREW CLAMP, #56 (3-1/16" - 4")	2
23	AF4008	GROMMET, 1-1/16" OD x 1/2" ID x 7/16" THK	1
24	49000063	HOSE, 3/4" I.D. 30"	1
25	LB698-15	CARB EO Label (D-698-15)	1



2009-18 RAM 1500, 2019 RAM 1500 CLASSIC, 5.7L ENGINE

This product has been granted CARB EO D-698-15 for the above applications.

2013-18 RAM 2500/3500, 5.7L ENGINE





The above applications are legal under the provisions of EPA's Tampering Policy dated November 23rd, 2020. The company has reasonable basis (test results) to verify that this product allows the vehicle to operate within legal emissions standards and is therefore legal to be sold for on-street use in all states that accept the legal provisions of the Clean Air Act and the EPA Tampering Policy. This product is NOT LEGAL FOR SALE OR USE IN THE STATE OF CALIFORNIA. Testing with the California Air Resources Board, in order to achieve 50-state compliance, is pending with CARB. Once testing is complete with California, and an E.O. number is issued, this product will be updated to 50-state legal status.

Removal: Please refer to vehicle manufacturer's recommendations regarding removal of components.

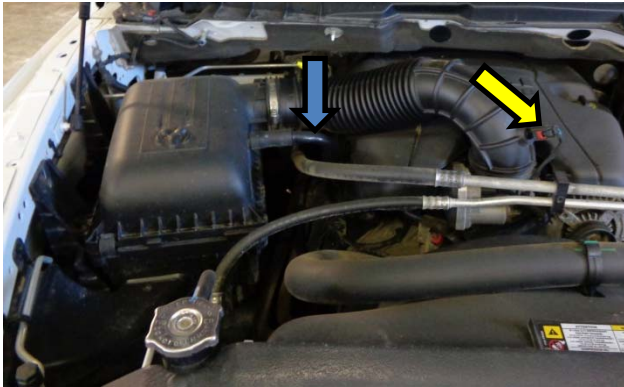
1. Turn off the ignition.



2. Disconnect the air-temperature sensor plug  on the intake tube by depressing the rocking tab and gently pulling away. Next, disconnect the crankcase breather hose  from the stock air- box. NOTE: We highly recommend that customers retain their factory air intake system.

4. With the stock air intake assembly lying on a flat surface, remove the stock air temperature sensor from the intake tube by twisting counter-clockwise and gently pulling outward simultaneously. Next, remove the O-ring from the sensor body and lube the area with a sensor-safe grease. Retain in a safe place.

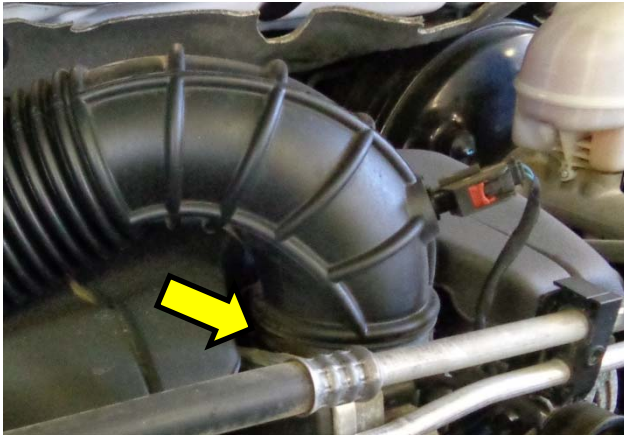

3. Loosen the hose clamp  retaining the factory intake tube to the throttle body and remove the entire stock air-box/intake tube assembly from the vehicle by lifting straight up and out. Place the assembly on a flat stable surface for further steps.

5. Turn the stock air intake assembly over and remove one of the rubber grommets from the base and retain for use on the FM Cold Air Intake System.



6. Remove the engine cover by grasping the front edge and lifting up and then pulling forward and set aside for reinstallation. It is recommended that you cover the throttle body intake with a clean cloth.



7. Remove the crankcase vent tube → from the engine. Replace the stock tube with the included hose/clamps. Route in the same path, trimming off any excess length after install of the FM system.



8. Remove the front retaining bolt → from the stock air-box frame on the fender and retain. Next, remove the bolt on the front cross-frame behind the headlight assembly as shown → and retain.

Assembly: Assemble the FM Cold Air Intake using the illustration on the front page for reference.



9. Begin assembly of the FM Cold Air Intake System by removing the components and hardware from the packaging and organizing the contents (including the fasteners) by thread and type to avoid confusion.

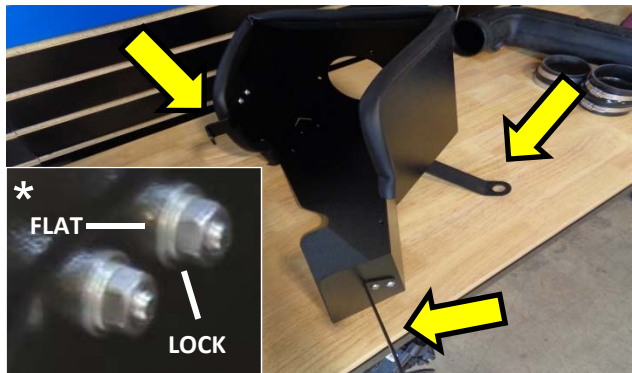

10. First, attach the 3 metal brackets → to the FM heat-shield using the supplied ¼" bolts/nuts and corresponding flat/lock washers installed under the nut-side as shown*. Tighten all fasteners securely.



11. Next, insert the rubber grommet that was previously retained from the stock air-box into the large hole on the single-bolt bracket on the base of the heat shield so that the beveled hole faces down.

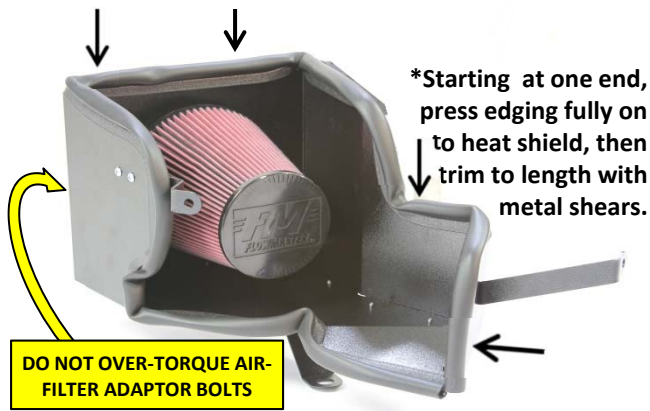

12. Using the (3) three 6mm bolts/washers, secure the air-filter adaptor to the heat-shield assembly. Next, install the rubber edging as above *, then securely attach the provided FM air-filter/clamp assembly.



13. Install the barbed fitting → into the brass threaded insert on the FM intake tube as shown.* Install the provided rubber couplers/clamps onto the FM intake tube and leave loose to allow for rotation.



14. Install the provided rubber grommet into the hole on the FM intake tube and insert the previously retained air temperature sensor fully by twisting clockwise and pressing in at the same time.



15. Insert the assembled FM intake system into the vehicle as shown*. Attach the extended crankcase vent hose/clamp. Connect the air temperature sensor plug and secure the intake tube on the throttle body.

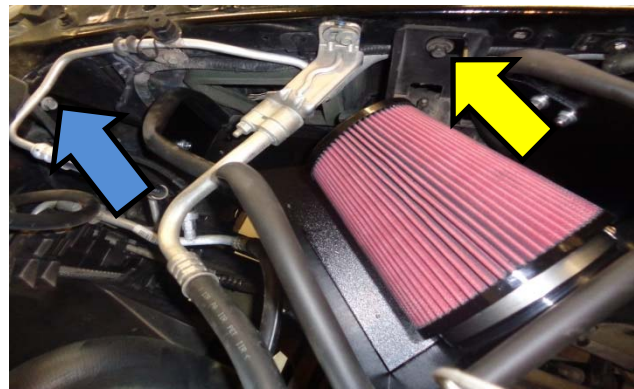

16. Reinstall the two previously removed bolts on the fender → and the front cross-frame → to secure the FM air-intake assembly. Check all fitment /fasteners and reattach the negative battery cable.

FLOWMASTER CARB EO #
THE PERFORMANCE TECHNOLOGY COMPANY™

DELTA FORCE PERFORMANCE INTAKE

D-698-15

FLOWMASTER INC. • 866-464-6553
 1801 RUSSELLVILLE ROAD, BOWLING GREEN, KY 42101

17. Affix the **CARB EO label (25)** to a clean, readily-visible location under the hood (e.g., near the hood latch). Congratulations, the installation of your **FLOWMASTER** performance air intake kit is now complete!