

INSTALLATION INSTRUCTIONS

MSD Ultra 6AL Plus Ignition Control PN 6523 (Red), PN 65233 (Black)

ONLINE PRODUCT REGISTRATION: Register your MSD product online. Registering your product will help if there is ever a warranty issue with your product. Go to www.msdisignition.com/registration/

Parts Included:

1 - MSD Ultra 6AL Plus
1 - Mag Pick-up Harness, PN 8860

1 - Main Harness
1 - Parts Bag

Download the "MSD Ultra 6AL" app
from Google Play or the App Store.

Note: The Ultra 6AL Plus has not been CARB certified, therefore it is not legal for California use.

Important: When installing the Ultra 6AL Plus Series Ignition, timing will be affected, reset to your engine's specifications.

Note: The MSD Ultra 6AL Plus uses its own custom app for monitoring and feature editing. The unit can also interface with the MSD View Software.

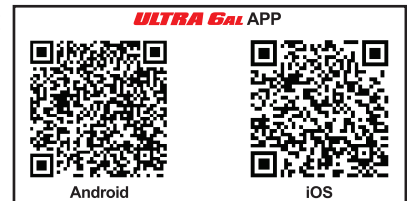

For certain applications, the MSD Ultra 6AL Plus can be used as an ignition amplifier with limiter functions and no more than 10 degrees of step retard.

OPERATION AND FEATURES

DIGITAL OPERATION

The Ultra 6AL Plus Series continues to use a high speed controller that can make extremely quick compensations to the output voltage, multiple spark series, timing and rpm limits while maintaining precise timing and accurate rev limiting. The circuits and controller of the MSD have been thoroughly filtered to create protection against Electro Magnetic Interference (EMI).

CAPACITIVE DISCHARGE

The Ultra 6AL Plus Series feature a capacitive discharge ignition design. The majority of stock ignition systems are inductive ignitions. In an inductive ignition, the coil must store and step up the voltage to maximum strength in between each firing. At higher rpm, since there is less time to charge the coil to full capacity, the voltage falls short of reaching maximum energy which results in a loss of power or top end miss.

The MSD Ignition features a capacitor which is quickly charged with 540 - 555 volts and stores it until the ignition is triggered. With the CD design, the voltage sent to the coil positive terminal is always at full power even at high rpm.

MULTIPLE SPARKS

The MSD produces full power multiple sparks for each firing of a plug. The number of multiple sparks that occur decreases as rpm increases, however the spark series always lasts for 18° of crankshaft rotation. Above 3,000 rpm there is simply not enough "time" to fire the spark plug more than once, so there is only one powerful spark.

Note: Solid Core spark plug wires cannot be used with an MSD Ignition.

Note: Do not use digital or dial back timing lights.

PROTECTION

The Ultra 6AL Plus Series have a built in reverse polarity protection circuit. This will protect the ignition in the event that the main battery leads are reversed.

WARNING: During installation, disconnect the battery cables. When disconnecting the battery always remove the Negative cable first and install it last.

GENERAL INFORMATION

BATTERY

The Ultra 6AL Plus will operate on any negative ground, 12 volt electrical system with a distributor. The Ultra 6AL Plus can be used with 16 volt batteries and can withstand a permanent voltage up to 28 volts (double battery systems). The ignition will deliver a full voltage with a supply of 7 - 28 volts. If your application does not use an alternator, allow at least 15 amp/hour for every half hour of operation. The MSD uses about .8 Amps for every 1000 rpm. If the engine is cranked with the same battery or other accessories such as an electric fuel or water pump are used, the amp/hour rating should be higher.

COILS

The Ultra 6AL Plus ignition can be used with most stock coils and aftermarket coils designed to replace the stock coils. The line of MSD Blaster Coils are great for street and mild racing. For extended high rpm operation and maximum output, the Blaster HVC PN 8252 or HVC II PN 8253 are recommended. For more information on recommended coils, check with our Customer Service Department at 1-888-258-3835.

TACHOMETERS

The Ultra 6AL Plus features a Gray Tach Output wire that provides a trigger signal for tachometers, shift light or other add-on rpm activated devices. The Tach Output wire produces a 12 volt square wave signal with a 22% duty cycle.

Some vehicles with factory tachometers may require a Tach Adapter to operate with the MSD. For more information on Tachometers and MSD Tach Adapters, see the Tachometer Section on page 6. If your GM vehicle has an in-line filter it may cause the tach to drop to zero on acceleration. If this occurs, bypass the filter.

SPARK PLUGS AND WIRES

Spark plug wires are very important to the operation of your ignition system. A good quality, helically wound wire and proper routing are required to get the best performance from your ignition, such as the MSD 8.5mm Super Conductor Wire. Helically wound wires provide a good path for the spark to follow while keeping Electro Magnetic Interference (EMI) to a minimum. Excessive EMI, such as the amount that solid core wires produce, will interfere with the operation of the MSD. **Solid Core spark plug wires cannot be used with an MSD Ignition.**

Routing: Correct routing of the plug wires is also important to performance. Wires should be routed away from sharp edges and engine heat sources. If there are two wires that are next to each other in the engine's firing order, the wires should be routed away from each other to avoid inducing a spark into the other wire. For example, in a Chevy V8, the firing order is 1-8-4-3-6-5-7-2. The #5 and #7 cylinders are next to each other in the engine and in the firing order. If the voltage from the #5 wire is induced into #7 wire, detonation could occur and cause engine damage.

To add more heat protection to your plug wires, MSD offers Pro-Heat Guard, PN 3411. This is a glass woven and silicone coated protective sleeve that you slide over your plug wires.

Spark Plugs: Choosing the correct spark plug design and heat range is important when trying to get the best performance possible. Since there are so many engine combinations and manufacturers, MSD does not recommend which plug or gap is exactly right for your application.

It is recommended to follow the engine builder or manufacturer's specification for spark plugs. With that, you

can then experiment with the plug gap by opening them in 0.005" increments, then testing until the best performance is obtained. (See Table 1.) These examples are just starting points to get you going in the right direction. Every application is different and should be tested and tuned.

COMPRESSION	SPARK PLUG GAP
Up to 10.5:1	0.050" - 0.060"
10.5:1 - 13.0:1	0.040" - 0.050"
Above 13.0:1	0.035" - 0.045"

Table 1. Spark Plug Gap

Welding: If you are welding on your vehicle, to avoid the chance of damage, always disconnect **both** Heavy Power cables of the MSD (You should also disconnect the tach ground wire too).

Distributor Cap and Rotor: It is recommended to install a new distributor cap and rotor when installing the MSD Ignition Control. The cap should be clean inside and out especially the terminals and rotor tip. On vehicles with smaller caps, it is possible for the air inside the cap to become electrically charged causing crossfire which can result in misfire. This can be prevented by drilling a couple vent holes in the cap. The holes should be placed between the terminals, at rotor height and face away from the intake. If your environment demands it, place a small piece of screen over the hole to act as a filter.

MOUNTING

The MSD Ultra 6AL Plus must be mounted in a sturdy, dry location and not exposed to extreme heat. It is not recommended to mount the unit in an enclosed area such as the glove box. It should be mounted using the included rubber isolators to limit excessive vibration and to provide access to the connector tab for harness removal. The unit should not be immersed or subjected to direct spray from a power washer. When you find a suitable location to mount the unit, make sure the wires of the ignition reach their connections. Hold the Ignition in place and mark the location of the mounting holes. Use a 3/16" bit to drill holes for the mounting hardware.

WIRING

GENERAL WIRING INFORMATION

Wire Length: All of the wires of the MSD Ignition may be shortened as long as quality connectors are used or soldered in place. To lengthen the wires, use one size bigger gauge wire (12 gauge for the power leads and 16 gauge for the other wires) with the proper connections. All connections must be soldered and sealed.

Grounds: A poor ground connection can cause many frustrating problems. When a wire is specified to ground, it should be connected to the battery negative terminal, engine block or chassis. There should always be a ground strap between the engine and the chassis. Always securely connect the ground wire to a clean, paint free metal surface.

Ballast Resistor: If your vehicle has a ballast resistor in-line with the coil wiring, it is recommended to bypass it. See more information under the heading "Ballast Resistor & Engine Run-On"

Routing Wires: The MSD wires should be routed away from direct heat sources such as exhaust manifolds and headers and any sharp edges. The trigger wires should be routed separate from the other wires and spark plug wires. It is best if they are routed along a ground plane such as the block or firewall which creates an electrical shield. The magnetic pickup wires should always be routed separately and should be twisted together to help reduce extraneous interference.

Cylinder Select: The Ultra 6AL Plus is set for operation on 8-cylinder engines by default. See section 'Cylinder Select' on page five.

Pink - Step Retard:

Single stage retard step is activated when 12 volts are applied to the Pink wire. The retard will remain until the 12 volts are removed (OR active when RPM is above the RPM value/setting). Connect to a nitrous solenoid activation wire or switch on the shifter. Retard is adjustable from 0 to 9.9 degrees in 1/10-degree increments.

Blue - 2-Step:

The Launch Rev Limiter low rpm limit is active when 12V is applied. Rev limit returns to the high limit when 12V is removed.

Lt Blue - Burnout Rev Limit:

Burnout Rev Limit is active when 12V is applied. This overrides other rev limits. It is recommended to have this wire switched from an outside source such as the crew chief before the burnout.

The Ultra 6AL Plus uses a main wiring harness that connects to the ignition through a sealed and locked connection.

POWER LEADS			
The two larger 14 gauge wires are for direct battery voltage to the ignition. The ignition is load protected from reverse battery connections.			
Heavy Red	4&14	Battery Power	This wire connects directly to the battery positive (+) terminal or a positive battery junction such as the starter solenoid. Note: Do not connect to the alternator
Heavy Black	9 &19	Battery Ground	Connects to a good ground, either at the battery negative (-) terminal or to the engine.
Black	18	Ref GND	Reference ground (Optional)
Red	5	Ignition	Switched 12V (Ignition)
Black	2	Coil (-)	This terminal is the ONLY wire that makes electrical contact with the negative coil terminal.
Orange	3	Coil (+)	This terminal is the ONLY wire that makes electrical contact with the positive coil terminal.
TRIGGER WIRES			
The Points circuit (White), Magnetic Pickup circuit (Green/Violet) and the Hall Effect Input (Red/Black/Green) can be used to trigger the MSD Ignition. Only one should be used at a time.			
White	17	Points	Connect to breaker points, electronic ignition amplifier output or to the Yellow wire of an MSD Timing Accessory. The Magnetic Pickup connector (Violet/Green) and the Hall Effect input are not used.
Violet Green	7 8	Magnetic Pickup	Magnetic Pickup. Plugs directly into an MSD distributor or crank trigger. It will also connect to aftermarket pickups. The Violet wire is positive (+) and the Green wire is negative (-). The White wire and Hall Effect input sensor are not used.
CRANK PICK UP SENSOR			
Red Green Black	5 20 18	Crank Sensor	Hall Effect input - Red supplies +12V to the sensor, black supplies ground and green is the Hall Effect signal input. The White wire and Mag Pickup connector are not used with this configuration.
ACCESSORIES			
Gray	15	Tach	Output tach wire which connects to the tachometer trigger wire or other rpm activated device.
Pink	1	Step Retard	When 12 volts are supplied, the Step Retard is activated.
Lt. Blue	12	Burnout Rev Limit	When 12 volts are applied the Burnout Rev Limit is active. This overrides other rev limits. It is recommended to have this wire switched from an outside source.
Dark Blue	11	Two-Step	When 12 volts are supplied, the Launch Rev Limiter RPM value is active.
MSD CAN (FOR USE WITH THE POWER GRID)			
Black	6		CAN LO
Gray	13		Reference Ground (Yellow Sleeve)
Red	16		CAN HI

Table 2. Wiring Table

PRESTART CHECK LIST

The only wires connected to the coil terminals are the MSD Orange to coil positive and Black to coil negative.

- The small Red wire of the MSD is connected to a switched 12 volt source.
- The MSD power leads are connected directly to the battery positive and negative terminals.
- The battery is connected and fully charged if not using an alternator.
- The engine is equipped with at least one ground strap to the chassis.
- Default 8-Cylinder setting can be changed to 4 or 6-cylinder using the "Mode" rotary switch. (See **Cylinder Select**)
- Download the **MSD Ultra 6AL** App on your device.
 - Select your Ultra 6AL Plus to pair device.

CYLINDER SELECT

The 6AL Plus is set at the factory for use on 8-cylinder engines. If you are installing on a 4 or 6 cylinder engine, you will use the Mode switch setting to select cylinders. **(Figure 1)** See the Table 3 for available preconfigured selections.

MODE SWITCH SELECTION CHART

The Mode switch sets the Cylinder count, a start retard, and Rev Limit. **Table 3** lists detailed 'Mode' settings.

MODE SWITCH SELECTION CHART	
MODE Switch Position	Max Engine RPM / Number of Cylinders Selected / Start Retard Selected / Rev Limit
0	Max Engine RPM / 8 Cyl, 0° Start Retard / Rev Limit Set
1	Max Engine RPM / 8 Cyl, 10° Start Retard / Rev Limit Set
2	Max Engine RPM / 8 Cyl, 20° Start Retard / Rev Limit Set
3	Max Engine RPM / 6 Cyl, 0° Start Retard / Rev Limit Set
4	Max Engine RPM / 6 Cyl, 10° Start Retard / Rev Limit Set
5	Max Engine RPM / 6 Cyl, 20° Start Retard / Rev Limit Set
6	Max Engine RPM / 4 Cyl, 0° Start Retard / Rev Limit Set
7	Max Engine RPM / 4 Cyl, 10° Start Retard / Rev Limit Set
8	Max Engine RPM / 8 Cyl, 0° Start Retard / Rev Limit Set
9	Max Engine RPM / 8 Cyl, 0° Start Retard / Rev Limit Set

Table 3. Switch Mode Chart

When the Mode switch is set to 0, 8 or 9, the unit defaults to 8 cylinder, 0° start retard operation.

When the Mode switch is set to positions 1-7, the unit will be set to the corresponding setting in the Mode Switch Selection Chart.

To see the current settings in the app when the 'Rotary Dials' are used as the Main Timing Source:

1. Select the Data Tab.
2. Select the add icon .
4. Add 'Start Retard', 'Cylinder Select' and 'Timing Source'

Note: Each Monitor item needs to be added separately. (See Data Tab on page 11.)

The Data Tab will now display the Mode switch details.

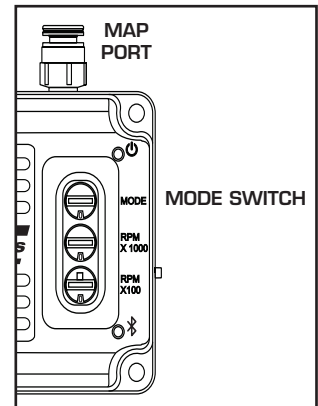

Figure 1. Mode Switch & MAP Port

MAP INPUT:

A Manifold Absolute Pressure sensor is integral to the unit. It uses 1/4" Camozzi fitting and is rated at 4 Bar. **(Figure 1)**

Using it can advance your timing under engine vacuum and retard it under boost. It is recommended that you use it, but not required unless you are using forced induction.

TROUBLESHOOTING

Every MSD Ignition undergoes numerous quality control checks including a four hour burn-in test. If you experience a problem with your MSD, our research has shown that the majority of problems are due to improper installation or poor connections.

The Troubleshooting section has several checks and tests you can perform to ensure proper installation and operation of the MSD. If you have any questions concerning your MSD, call (888) 258-3835. MSD technicians are available from 8:00 a.m. to 5:00 p.m. Monday - Friday (Central time).

LED

The LED monitors several operating conditions. When the ignition is functioning properly, the LED will illuminate green above idle speeds. If there is a problem with the ignition system the LED color will determine status, **see Table 4** and the following details for troubleshooting in this section.

LED COLOR	CONDITION
RED	Coil Shorted/Converter Shorted/Overtemp
ORANGE	Key ON, Engine OFF (No RPM)
GREEN	Engine ON (RPM)

Table 4. LED Status

TACHOMETER COMPATIBILITY LIST		
AFTERMARKET TACHOMETER	WHITE WIRE TRIGGER	MAGNETIC TRIGGER CONNECTOR
AUTOGAGE	8910	8920
AUTOMETER	NONE	NONE
FORD MOTORSPORTS	NONE	NONE
MALLORY	NONE	NONE
MOROSO	NONE	NONE
STEWART WARNER (Voltage triggered)	8910	8920
S.W. & BI TORX	NONE	NONE
SUN	8910	8920
VDO	NONE	NONE
AMC (JEEP)	8910	8920
CHRYSLER	8910	8920
FORD (Voltage triggered)	8910	8920
GENERAL MOTORS	Bypass In-line Filter	Bypass In-line filter
IMPORTS	8910	8920

Note: On the list above, the trigger wire on the tachometers that are marked NONE may be connected directly to the Gray Tach Output Wire on the MSD 6AL Plus Ignition.

Table 5. Common Tachometer and Adapters

TACH/FUEL ADAPTERS

If your tachometer does not operate correctly or if you experience a no-run situation with your foreign vehicle you probably need an MSD Tach Adapter. **Table 5** lists common tachometers and if an Adapter is necessary.

TACH ADAPTERS

There are two types of Tach Adapters:

PN 8920: If you are using the Magnetic Pickup connector (Green and Violet wires) to trigger the MSD, you will need the PN 8920.

PN 8910: If your tachometer was triggered from the coil negative terminal (voltage trigger) and you are using the White wire to trigger the MSD you will need the PN 8910.

NO-RUN ON FOREIGN VEHICLES

Some foreign vehicles with fuel injection systems may require an MSD Tach/Fuel Injection Adapter to run with an MSD Ultra 6 Series Ignition. This is because many of these systems use the same trigger source to operate the MSD, the tachometer and the fuel injection. This results in a voltage signal that is too low to accurately trigger the fuel injection. To fix this, an MSD Tach Adapter, PN 8910, will remedy the problem on the majority of vehicles. If the PN 8910 does not fix the problem, the PN 8910-EIS will be required.

Note: Toyota models and Ford Probes will require the PN 8910EIS Adapter.

INOPERATIVE TACHOMETERS

If your tachometer fails to operate with the MSD installed you may need an MSD Tach Adapter. Before getting an Adapter, try connecting your tachometer trigger wire to the Gray tach wire of the MSD. This output produces a 12 volt, square wave (see 'Tachometers' on page 2). If the tach still does not operate, you will need a Tach Adapter.

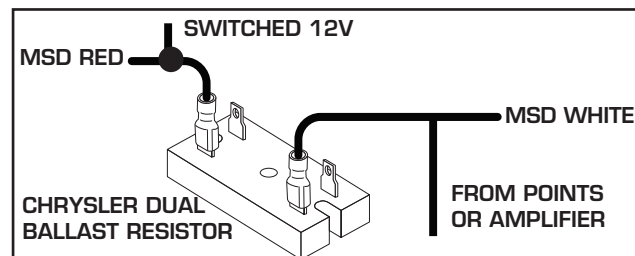

Figure 2 Wiring the Dual Ballast Resistor

BALLAST RESISTOR

If you have a current trigger tach (originally coil positive) and use the White wire of the MSD, you can purchase a Chrysler Dual Ballast Resistor (used from 1973-1976) and wire it as shown in **Figure 2**.

ENGINE RUN-ON

If your engine continues to run even when the ignition is turned Off, you are experiencing engine Run-On. This usually only occurs on older vehicles with an external voltage regulator. Because the MSD receives power directly from the battery, it does not require much current to keep the unit energized. If you are experiencing run-on, it is due to a small amount of voltage going through the charging lamp indicator and feeding the small Red wire even if the key is turned off.

Early Ford and GM: To solve the Run-On problem, a Diode is supplied with the MSD in the parts bag. By installing this Diode in-line of the wire that goes to the Charging indicator, the voltage is kept from entering the MSD. **Figure 3** shows the proper installation for early Ford and GM vehicles.

Note: Diodes are used to allow voltage to flow only one way. Make sure the Diode is installed facing the proper direction (as shown in **Figure 3**).

Ford: Install the Diode in-line to the wire going to the "1" terminal.

GM: Install the Diode in-line to the wire going to terminal #4.

GM: 1973 - 1983 with Delcotron Alternators.

GM: Delcotron Alternators use an internal voltage regulator. Install the Diode in-line on the smallest wire exiting the alternator (**Figure 4**). It is usually a Brown wire.

Run-on Fix with a Dual Ballast resistor on other applications: On other applications where engine Run-On is experienced, a dual ballast resistor can be installed in-line to the MSD's small Red wire (**Figure 5**). This dual ballast resistor will keep voltage from leaking through to the MSD unit.

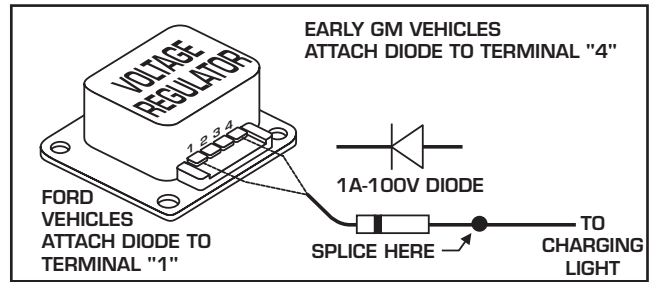

Figure 3 Installing the Diode to a Ford or GM Vehicle

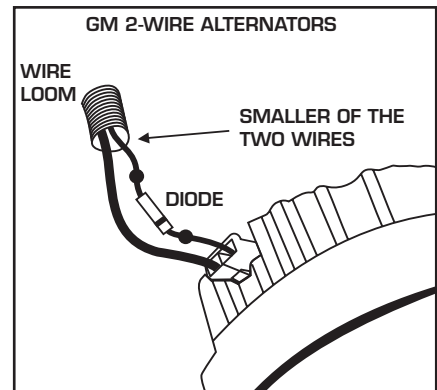

Figure 4 Installing the Diode to a 1973-1983 GM Vehicle

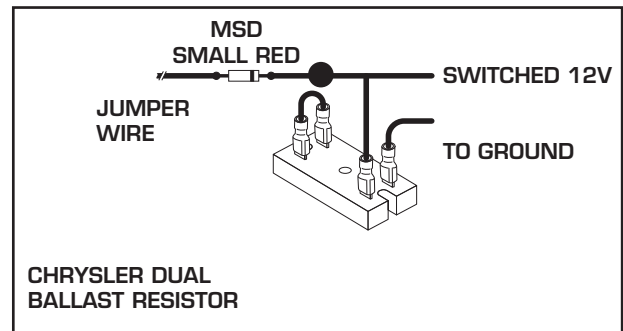

Figure 5 Wiring the Dual Ballast Resistor to fix Run-On

MSD ULTRA 6AL APP

The MSD App controls all the features of the MSD Ultra 6AL Plus controller using your device's bluetooth connection. The information that follows will briefly explain the features in the app.

HOME

The Home screen (**Figure 6**) displays the Engine Speed with Burnout, Rev and Launch RPMs. Also displayed are the Battery voltage and Step Retard and current product installed.

The Burnout, Rev Limit markers and Step Retard features can be updated right from the home screen. Simply tap on the feature and use the slider to update the RPM or Degree of Retard. (**Figure 7**)

DIAGNOSTICS

The Ultra MSD notifies the user if there are any alerts with the LED on the MSD and in app alerts. Tap the 'Diagnostics' icon for the Alerts window. (**Figure 8**)

ALERTS

Read Alerts: Alerts are listed from current and previous occurrences and remain until they are resolved and erased. (**Table 6**)

ALERTS	STATUS LED
Coil Shorted	RED
Converter Shorted	RED
Coil Shorted to Battery	RED
Over Temperature	RED
Coil Open	GREEN
Open Load	GREEN
Converter Low	GREEN
Converter Fault	GREEN
EEPROM Error	GREEN

Clear Alerts: This will erase all alerts.

SETTINGS

In the settings screen are the adjustable parameters. See **Figures 9 & 10**.

Table 6. MSD Ultra Alert List

REV LIMITER

Launch Rev Limiter: This is the maximum RPM the engine will be allowed to reach when 12 volts is applied to the dark blue wire. Adjustable from 2000 to 12000 RPM.

Launch Rev Limit Latched

When the Launch Rev Limit Latch is OFF, the Launch RPM (2 step) will activate any time the RPM is at or above the set Launch RPM. When this setting is ON, the engine rpm must be below 7/8

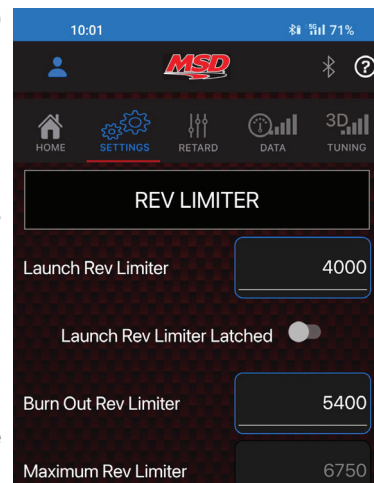

Figure 9 Setting Screen



Figure 6. Home Screen

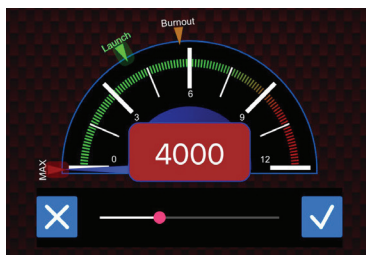

Figure 7. Slider adjustment

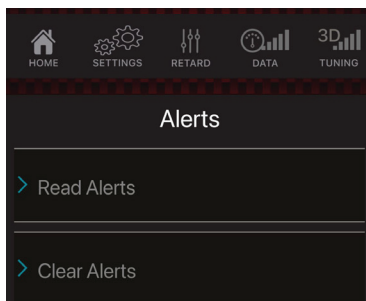

Figure 8. Alerts Screen

of the launch limit setting while 12 volts is applied to the Dark Blue wire to engage the Launch Limiter. The Launch RPM cannot become active unless the RPM falls below 7/8 of the set RPM.

For example: If set at 4000 RPM and the launch wire is activated, the launch limiter can only come on if the RPM falls below 3500. This prevents accidental activation while at high RPM (such as a faulty launch switch activating or activating it with the clutch during the run). This allows clutch cars to wire the Dark Blue wire directly to the clutch switch without the need to use a relay. If Latching is disabled, the Launch Rev Limiter will be engaged anytime the Dark

Blue wire receives 12 volts (such as during each shift) regardless of engine rpm.

Burn Out Rev Limiter: Activated when 12 volts are applied to the Light Blue wire. It overrides all other rev limiters and is typically connected to the line lock solenoid. It is adjustable from 2000 to 12000 RPM.

Maximum Rev Limiter: This is the over rev limit designed to protect the engine from damage. It is adjustable from 2000 to 12000 rpm.

STEP RETARD

Step Retard (Deg): Activated when 12 volts are applied to the Pink wire (nitrous input). Ignition timing Adjustable from 0 to 30 degrees. (Figure 12)

On Ramp Time (Sec): This is the time to reach full or total retard. Adjustable from 0 to 5 seconds.

Example: If 10 degrees of total retard is set with 1 second of ramp time, the MSD will retard 1 degree every 0.1 seconds until the full 10 degrees of timing is pulled. A '0' (zero) setting will cause an immediate timing retard of 10 degrees.

Off Delay (Sec): The time the Total Retard remains in effect after the “Step Retard” is deactivated. Adjustable from 0 to 5 seconds. This will also delay the “Off Ramp Time” from starting - meaning that it is additive with respect to the Off-Ramp Time.

Off Ramp Time (Sec): This will slowly remove the effect of the Total Retard - effectively ramping timing back into the motor instead of adding it instantaneously. Timing will start ramping back in after the “Off Delay” has expired. Adjustable from 0 to 5 seconds.

Engine (RPM): This is the minimum engine speed that must be met to retard the timing. Adjustable from 0 to 10000 RPM.

Max Timing Ref: This is the advance that is set with a locked distributor or crank trigger. The system controller will use this as its base for all timing marks and can never advance past the pre-set point. It is critical that this advance is set properly.

Note: When using EFI the max timing reference and the main timing must be the same number.

Max Retard: The max amount of total Retard that can be set.

MAIN TIMING SOURCE

Select how timing will be managed.

Switches: To activate the Rotary Dials, highlight and tap 'Update' to activate the use of the switches on the MSD.

3D Chart: For 3D graph tuning, select '3D Chart', tap 'Update' then select 3D Tuning to view and edit the graph.

2D Plot: Selecting '2D Plot' and 'Update' will allow setting both 'MainTiming' and 'Launch Timing' under the 'Retard Tab'.

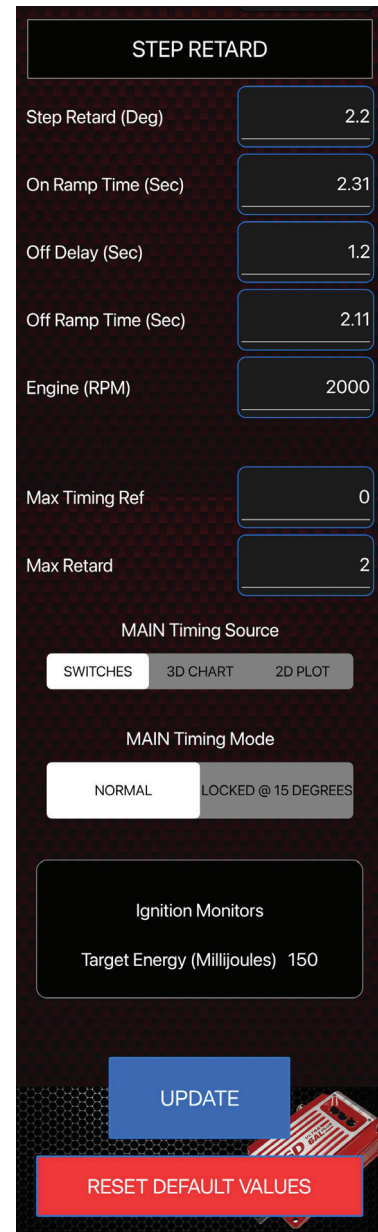

Figure 10. Settings Screen

MAIN TIMING MODE

Normal: Defaults to the base timing.

Locked @ 15 Degrees: This sets and locks timing at 15° BTDC when selected and submitted.

Using a timing light, users must verify that actual engine timing is 15-Degrees Before Top Dead

Center when this feature is enabled. Otherwise, the accuracy of all other commanded timing values will be suspect.

UPDATE

Sends updated values/parameters to the connected unit.

RESET DEFAULT VALUES

Resets the application values

RETARD TAB

Under the Retard tab will be the Main Timing and Launch timing plots to set Timing. **(Figure 11)**

Main Timing Plot: Sets the base Ignition Timing vs. Engine RPM. Timing will not advance past the Maximum Timing Ref (set in the Settings tab).

Timing will not retard more than -30 degrees from the Max Timing Ref (set in the Settings tab).

Launch Timing Plot: This plot allows for retarding the ignition timing based on the Time from Launch.

The Time from Launch will reset to '0 - Zero' during Launch Rev Limiter activation or '0 - Zero (Engine Off)' RPM. The first point in the plot will control timing offset during the Launch Rev limiter.

To edit the 2D chart, select the menu icon  found in the upper left hand corner of the app.

LOAD...: Load a previously saved plot.

SAVE AS...: Save the current plot to Load at another time.

EDIT PLOT: Update the plotting points for the desired timing curve.

CANCEL: Closes the Action screen and returns to the plot.

DATA TAB

A custom graph, digital readout or gauge can be created from a selection of parameters **(Table 5)** added by using the plus icon . **(Figure 12)** Each gauge or digital readout can be moved up or down, custom colors can be selected and display types can be changed as well as units, when applicable, by using the Edit button.

NOTE: A maximum of 12 parameters can be added for display.

NOTE: As the MSD temperature reaches an unsafe operating temperature, the spark energy decreases then cuts off when the unit reaches its maximum operating temperature threshold of 140°C/284°F.

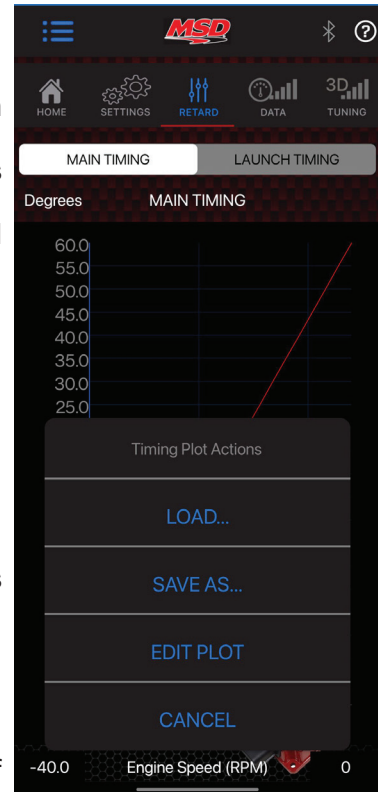

Figure 11. Retard Tab & Menu

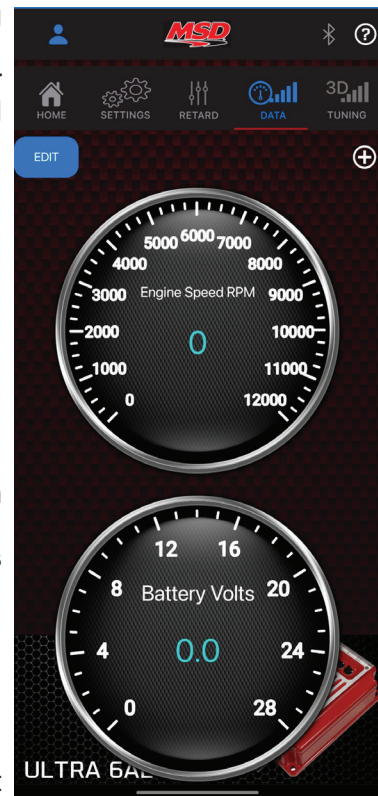



Figure 12. Data Screen

3D TUNING

Under the 3D Tuning tab will be the MAP vs RPM graph. (Figure 13)
 To edit the 3D chart, select the menu icon  found in the upper left hand corner of the app.

LOAD: Load a previously saved plot.

SAVE AS: Save the current plot to Load at another time.

EDIT TIMING TABLE: Update the plotting points for the desired timing curve. (Figure 14)

MAP: The MAP is adjustable from 0 to 400

RPM: Adjustable from 0 to 10000.

Cell: Adjustable from 0 to 60

CANCEL: Closes the Action screen and returns to the plot.

Pressure reading can be toggled from KPa to PSIA.

Note: When 'EDIT PLOT' is selected, the menu Updates to "VIEW CHART". Select 'VIEW CHART' to return to the Plot screen.

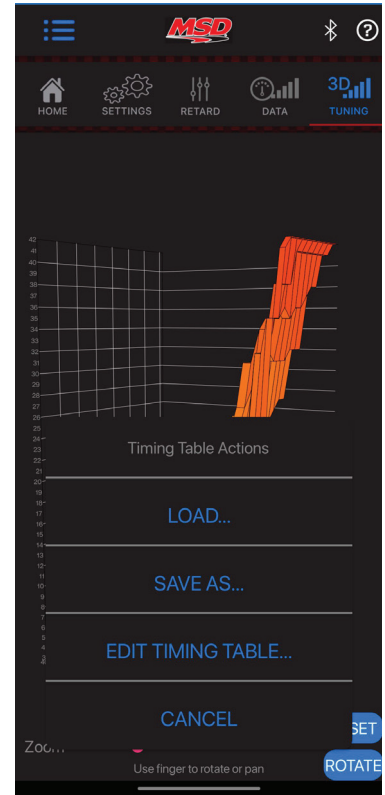

Figure 13. 3D Data Screen

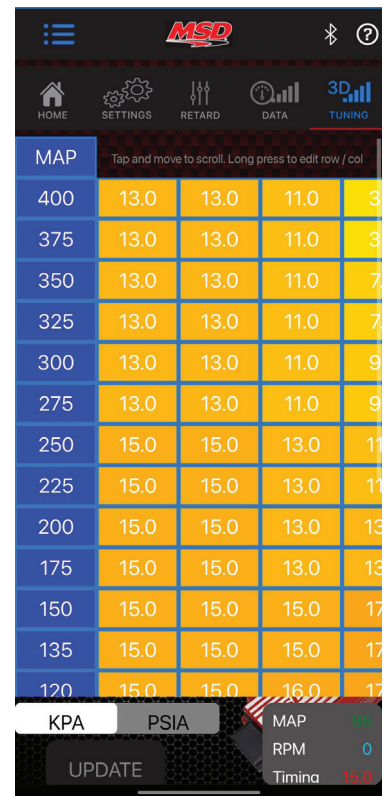

Figure 14. Timing Table

PAIRING MOBILE DEVICE TO THE MSD

When pairing your mobile device to the MSD Ultra 6AL Plus, make sure there is power to the ignition and the LEDs are on.

Before starting the App:

1. Press the Green reset button until the Wi-Fi LED blinks Red twice, then turns off (approximately 5 seconds)
2. Press the button again.
3. The Wi-Fi LED will flash Blue/Orange/Red and is now in pairing mode.
4. Open the App and it will pair with the MSD after permissions are granted, see permissions below for Apple and Android

FOR APPLE USERS:

Select 'OK' on the alert box to connect the Ultra 6AL Plus. (Figure 15)

FOR ANDROID USERS:

Select 'OK' on the **Alert Box** to enable the bluetooth services. (Figure 16)

Select 'Allow' in the location box to detect the MSD bluetooth (Figure 17). This will enable Bluetooth communication with your device.

Once paired, the MSD App Home Screen (Figure 18) will appear and settings can be modified for your application.

MSD APP CONNECTION

The MSD app can pair more than one unit, so confirming one or an additional unit will ensure it is added to your profile.

To connect a different MSD, such as the PN 6423, the App will need to be restarted otherwise an error will be displayed. (Figure 19)

If a 'Security check failed' window appears, proceed to follow instructions to reset and reconnect to the unit.

MISSES AND INTERMITTENT PROBLEMS

Experience at the races has shown that if your engine is experiencing a miss or hesitation at higher rpm, it is usually not directly the ignition. Most probable causes include faulty wiring, a coil or plug wire failure, arcing from the cap or boot plug to ground or spark ionization inside the cap. Several items to inspect are:

- Always inspect the plug wires at the cap and at the plug for a tight connection and visually inspect for cuts, abrasions or burns.
- Inspect the Primary Coil Wire connections. Because the MSD is a Capacitive Discharge ignition and it receives a direct 12 volt source from the battery, there will not be any voltage at the Coil Positive (+) terminal even with the key turned On. During cranking or while the engine is running, very high voltage will be present and no test equipment should be connected.

WARNING: Do not touch the coil terminals during cranking or while the engine is running.

- Make sure that the battery is fully charged and the connections are clean and tight. If you are not running an alternator this is an imperative check. Although these Ignition modules can run full power down to 7V battery – big advantage vs other Ignition modules.

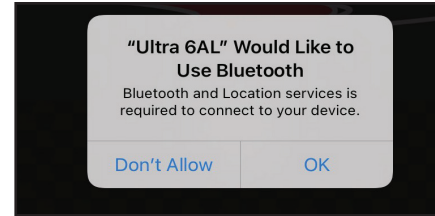

Figure 15 Alert Box (Apple)

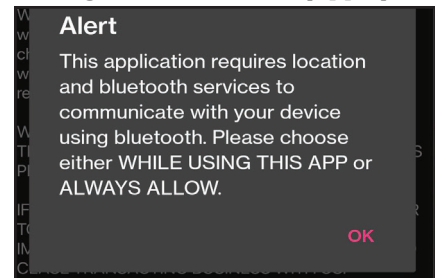

Figure 16 Alert Box (Android)

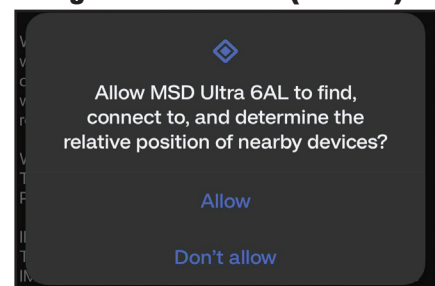

Figure 17 Location Box

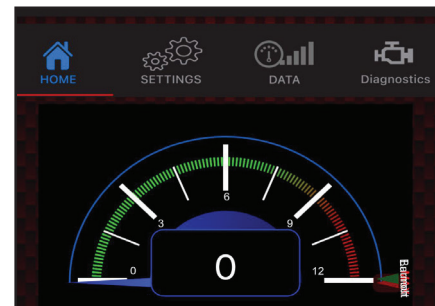

Figure 18 Home Screen

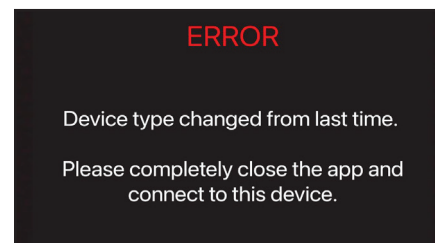

Figure 19 App Error

- Is the engine running lean? Inspect the spark plugs and complete fuel system.
- Inspect all wiring connections for corrosion or damage. Remember to always use proper connections followed by soldering and seal the connections completely.

If everything checks positive, use the following procedure to test the ignition for spark. MSD also offers an Ignition Tester, PN 8998 or PN 89981. This tool allows you to check your complete ignition system while it is in the car as well as the operation of rpm limits, activated switches and shift lights.

CHECKING FOR SPARK

If triggering the ignition with the White or Green wire: If you are using the white wire (points or electronic amplifier) of the MSD to trigger the ignition, follow these steps (Figure 20):

1. Make sure the ignition switch is in the "Off" position.
2. Remove the coil wire from the distributor cap and set the terminal approximately 1/2" from a good ground.
3. Disconnect the MSD White trigger or Green wire from the distributor points or the ignition amplifier.
4. Turn the ignition to the On position. **Do Not Crank the Engine.**
5. Tap the White or Green wire to ground several times. Each time you pull the wire from ground, a spark should jump from the coil wire to ground.
If spark is present, the ignition is working properly. If there is no spark skip to step 6.

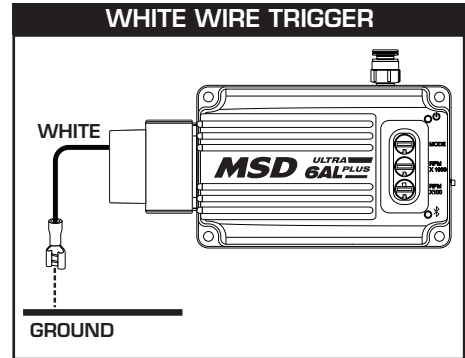

Figure 20 Checking for Spark with the White Wire

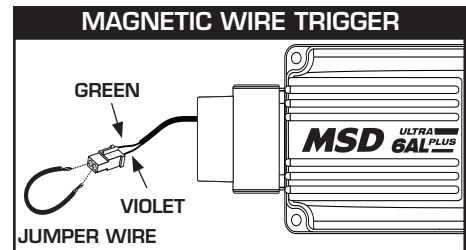

Figure 21 Checking for Spark with the Mag Pickup

Magnetic Pickup trigger:

1. Make sure the ignition switch is in the "Off" position.
2. Remove the coil wire from the distributor cap and set the terminal approximately 1/2" from ground.
3. Disconnect the MSD magnetic pickup wires from the distributor.
4. Turn the ignition to the On position. Do not crank the engine.
5. With a small jumper wire, short the MSD's Green and Violet magnetic pickup wires together several times (Figure 21). Each time you break this short, a spark should jump from the coil wire to ground.
If spark is present, the ignition is working properly. If there is no spark skip to step 6.
6. If there is no spark:
 - A. Inspect all of the wiring.
 - B. Substitute another coil and repeat the test. If there is now spark, the coil is at fault.
 - C. If there is still no spark, check to make sure there are 12 volts on the small Red wire from the MSD when the key is in the On position. If 12 volts are not present, find another switched 12 volt source and repeat the test.
 - D. If, after following the test procedures and inspecting all of the wiring, there is still no spark, the MSD Ignition is in need of repair. See the Warranty and Service section for information.

The following wiring diagrams illustrate numerous installations on different vehicles and applications. If you experience difficulties when installing your MSD, contact our Customer Support Department at (888) 258-3835. MSD technicians are available from 8:00 a.m. to 5:00 p.m. Monday - Friday (Central time), or e-mail us at: msdforms@msdperformance.com

MSD SYSTEMS Installing to an MSD Distributor/Crank Trigger

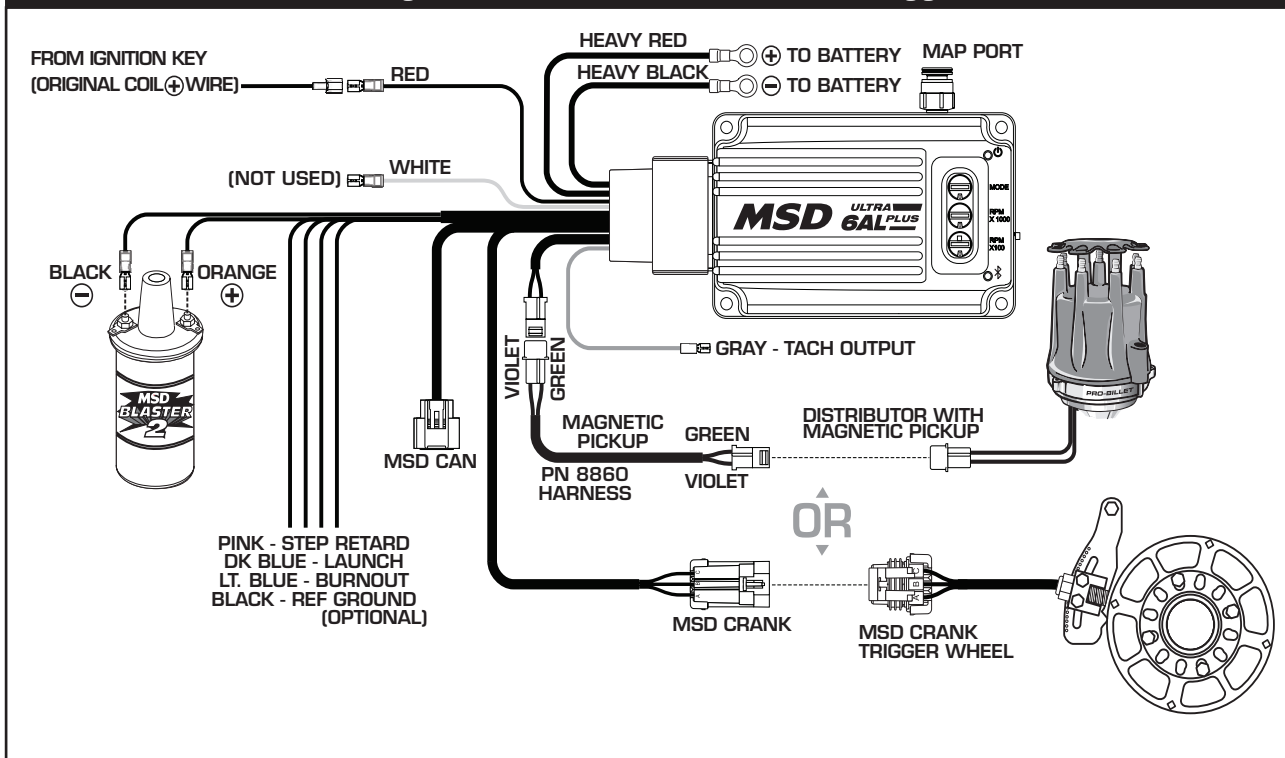

GM IGNITIONS Wiring a Dual Connector Coil.

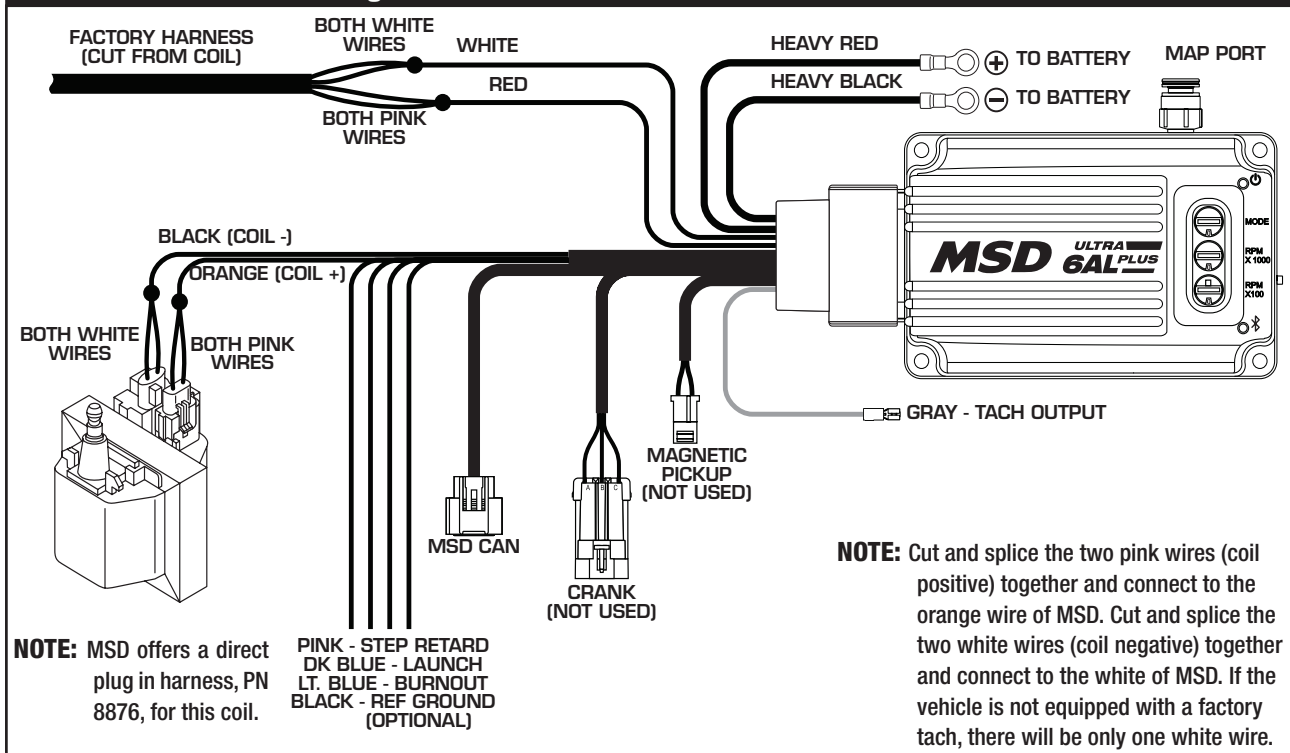

GM IGNITIONS Wiring the 1996 and up single connector coil without harness.

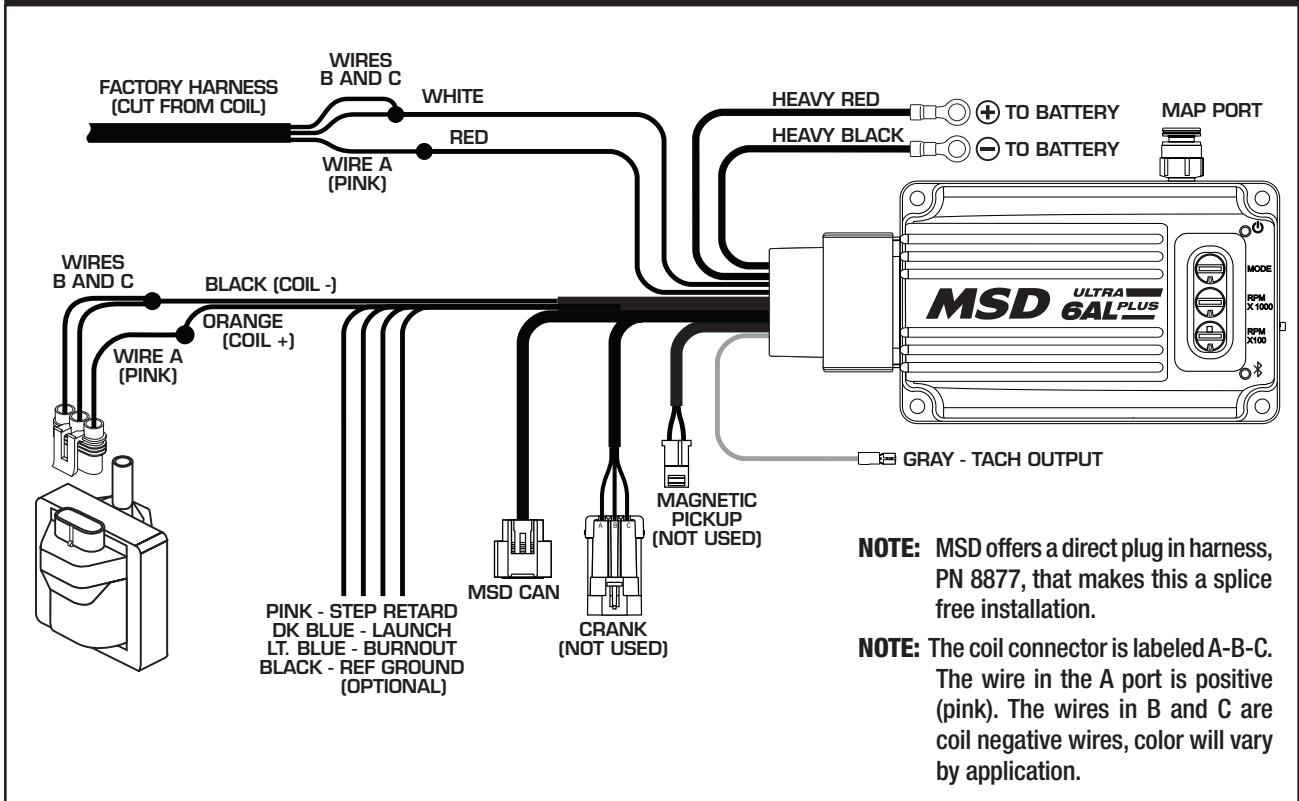

GM IGNITIONS Wiring with an MSD Wiring Harness.

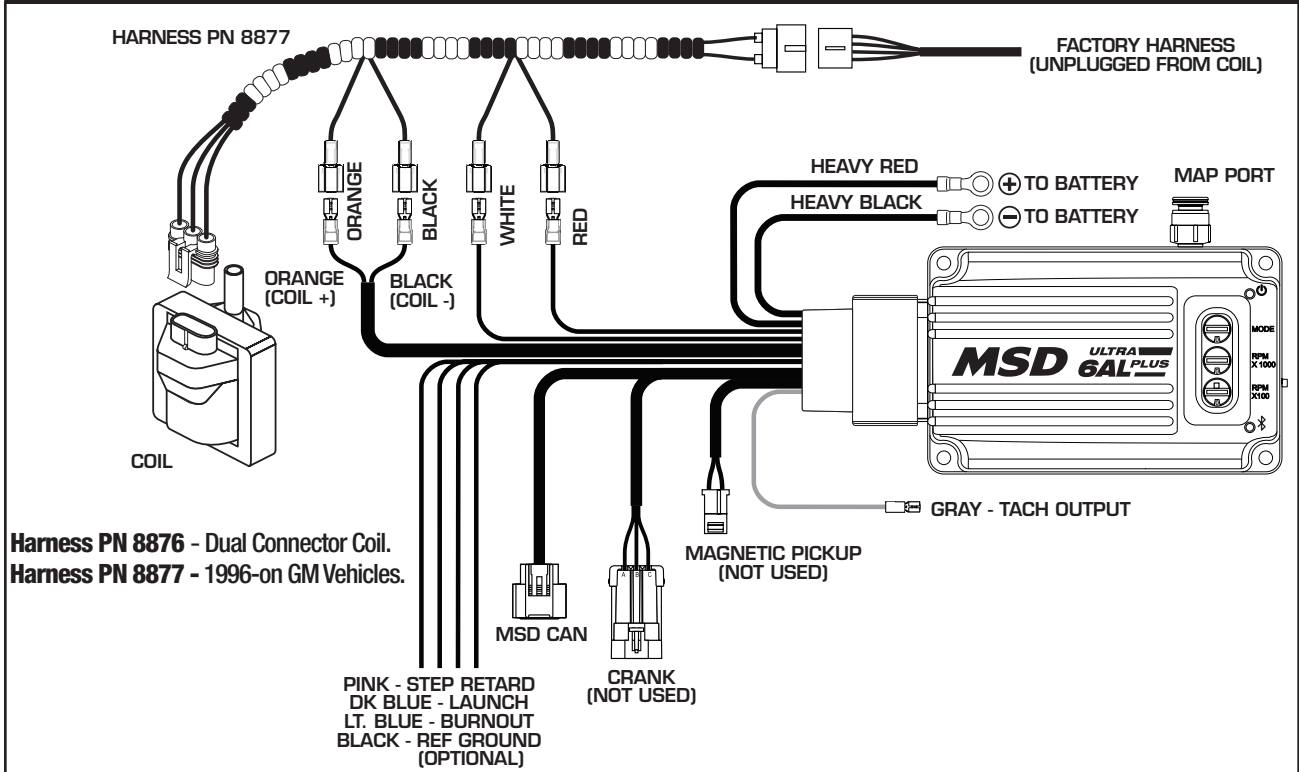

GM IGNITIONS GM Large Cap HEI Distributors

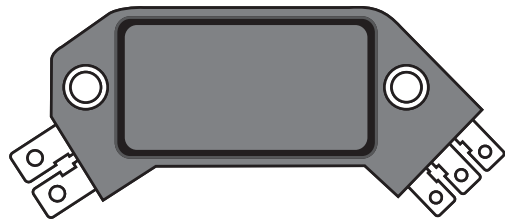
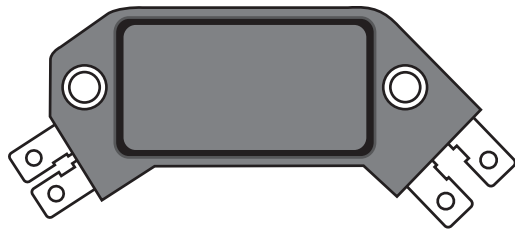

There are three different large cap HEI distributors. To identify which of the following diagrams fit your specific application, remove the distributor cap and rotor and locate the ignition module at the base of the distributor. Count the number of terminals on both ends of the module and follow the corresponding diagram. GM used 4, 5, and 7-pin modules in these distributors.

NOTE: Some 5-pin models may experience a hesitation or stall on deceleration. If this occurs, contact MSD Tech Line for the required bolt-in diode to correct the problem. MSD Tech Line 1-888-258-3835.

GM IGNITIONS Wiring an HEI 4-pin Module (Magnetic Pickup Trigger).

NOTE: The GM Ignition Module and condenser are removed and replaced with the supplied PN 8861 Harness.

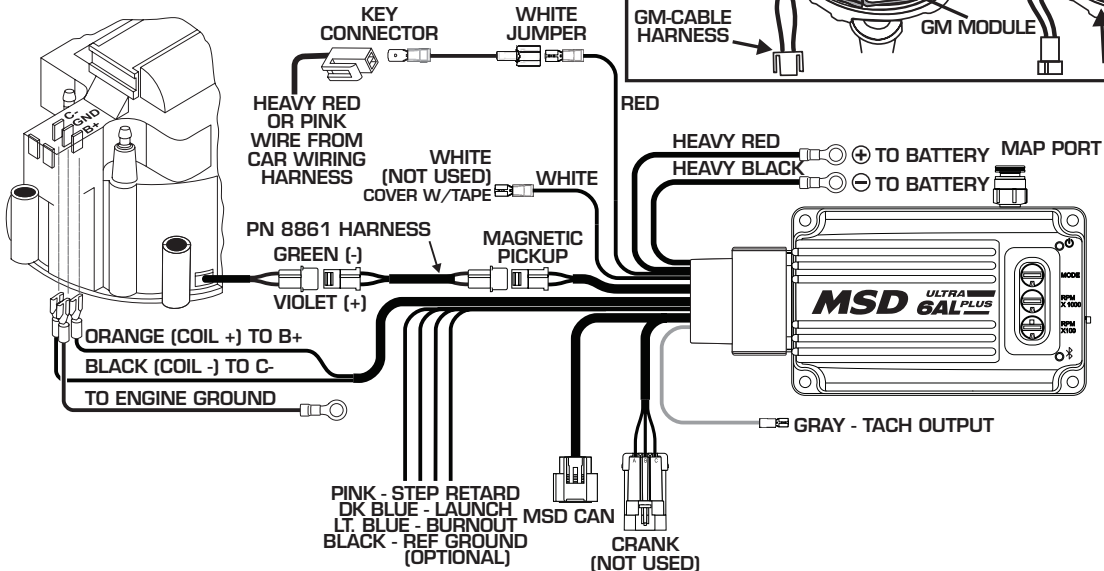
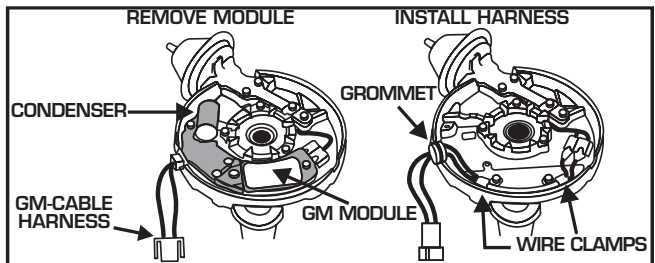

GM IGNITIONS Wiring an HEI 5 or 7-pin Module (Amplifier Trigger).

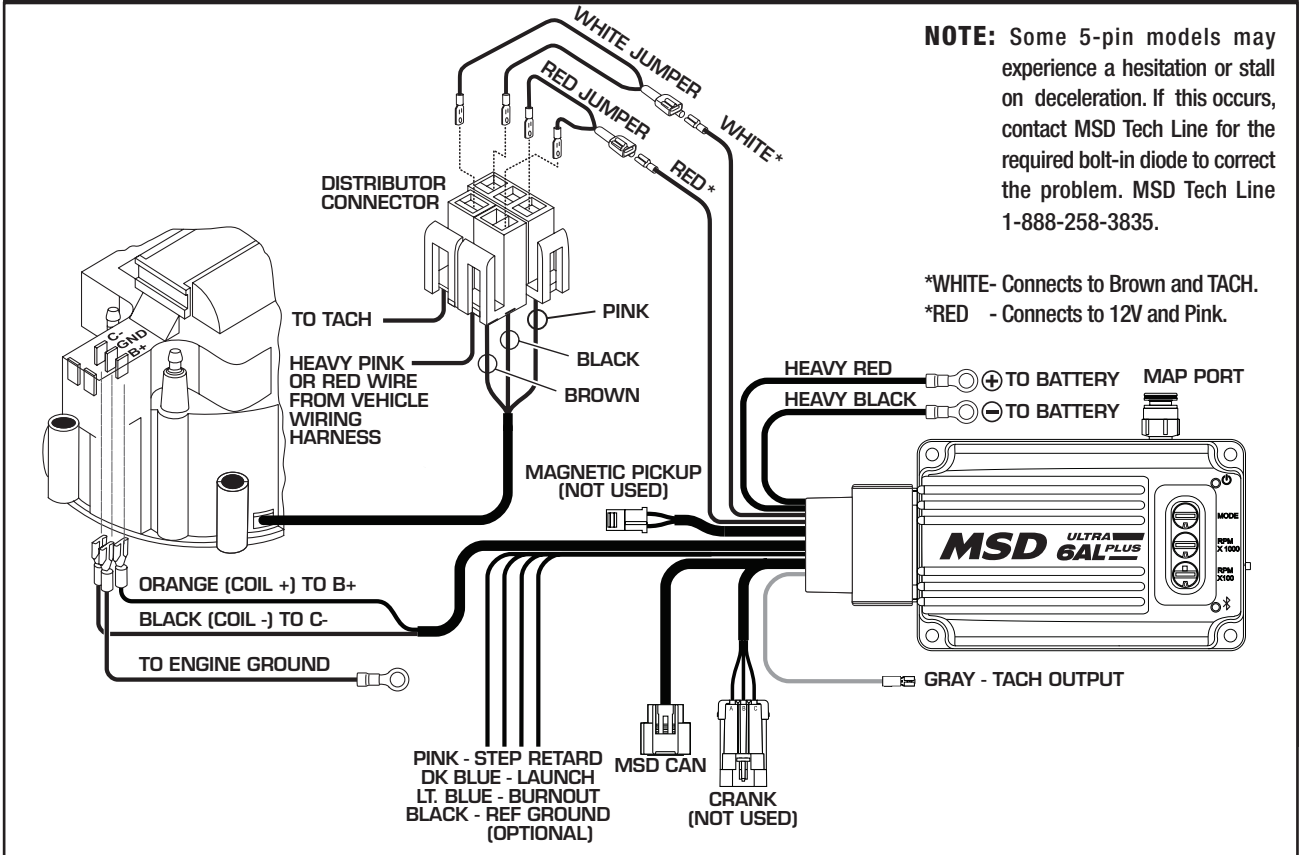

FORD IGNITIONS Wiring a Ford DuraSpark using White Wire Trigger.

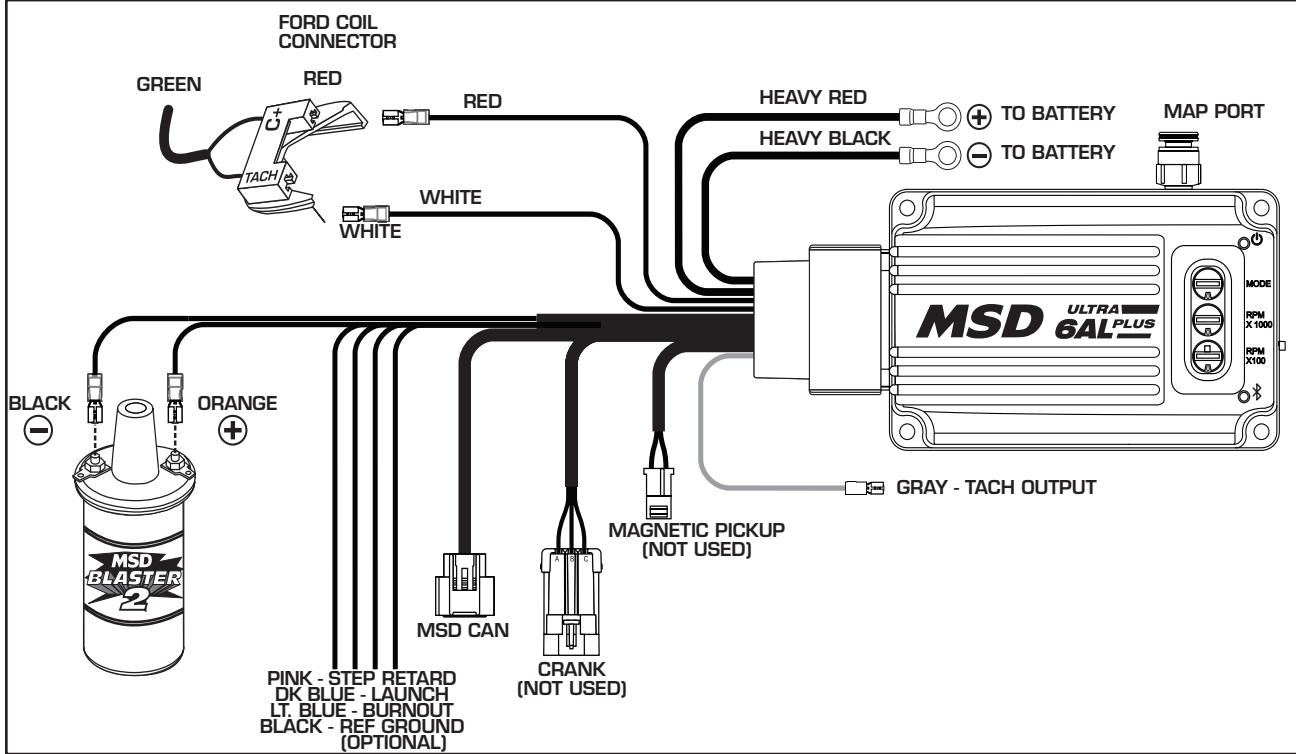

FORD IGNITIONS Wiring a Ford DuraSpark using Magnetic Pickup Trigger.

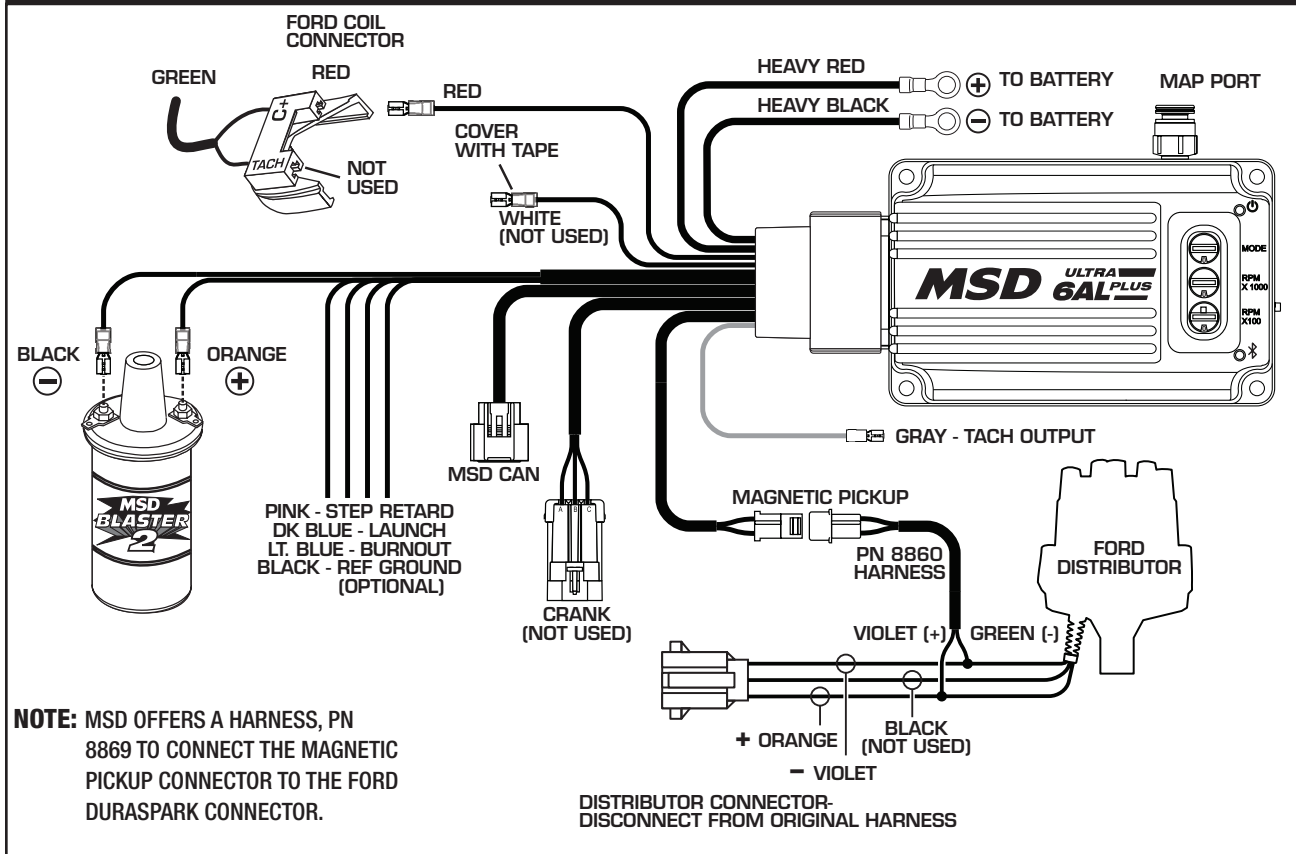

FORD IGNITIONS Wiring a Ford TFI with Harness, PN 8874.

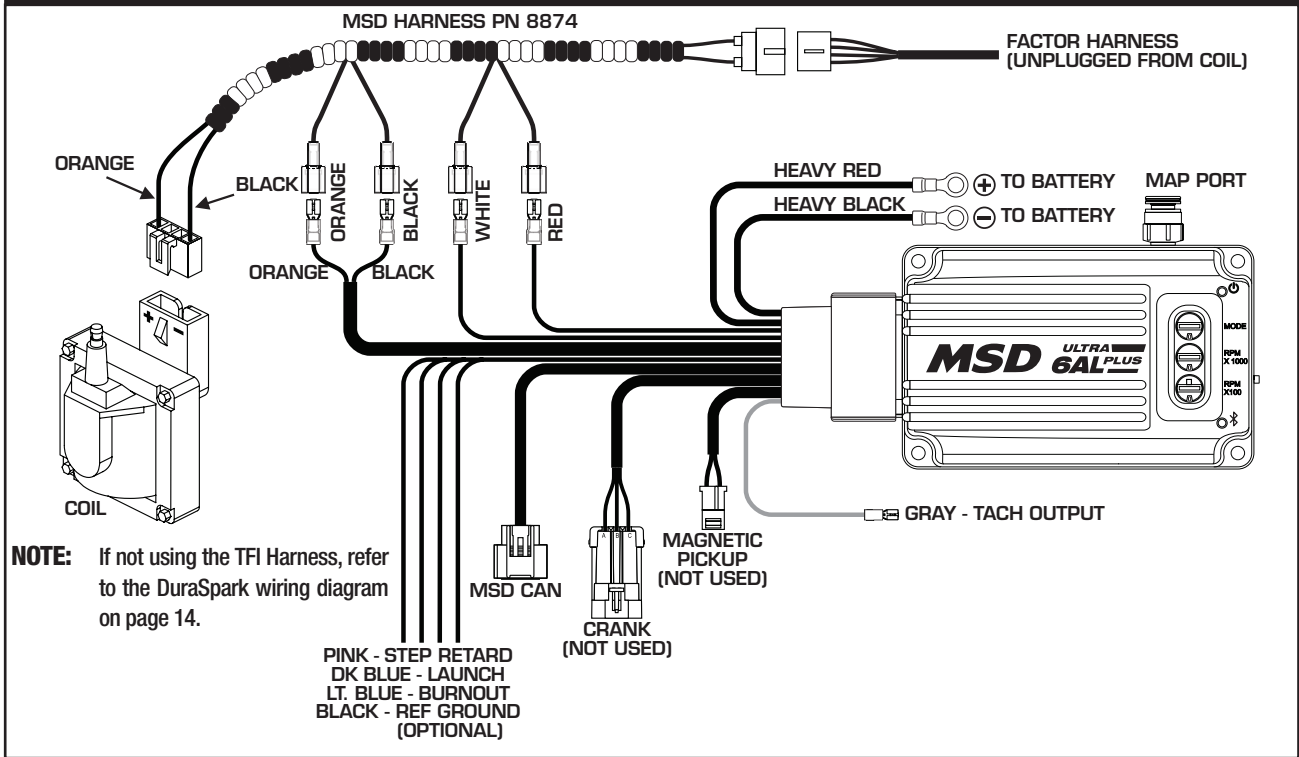

CHRYSLER IGNITIONS Wiring a Chrysler Electronic Ignition using Magnetic Pickup Trigger.

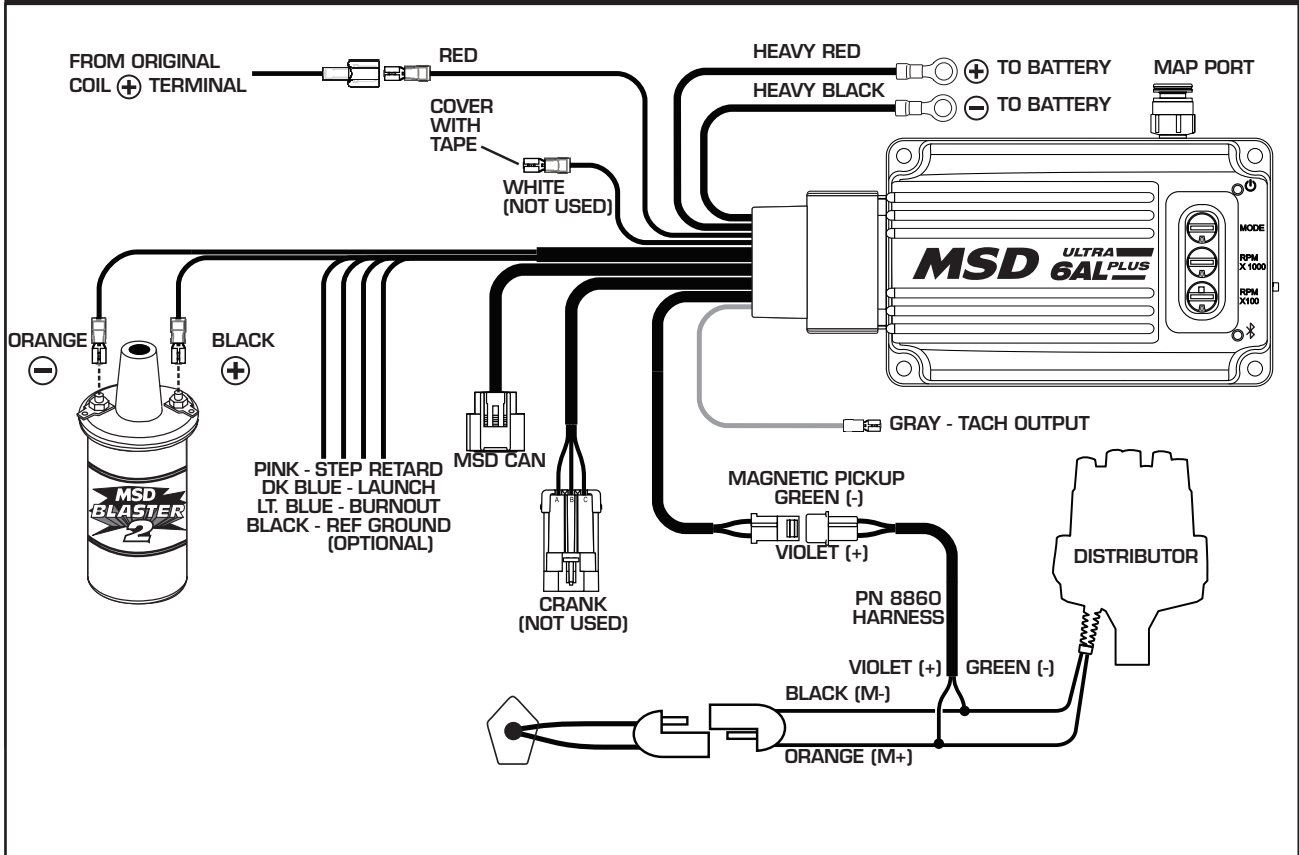

CHRYSLER IGNITIONS Wiring a Late Model Dodge with 2-pin connector.

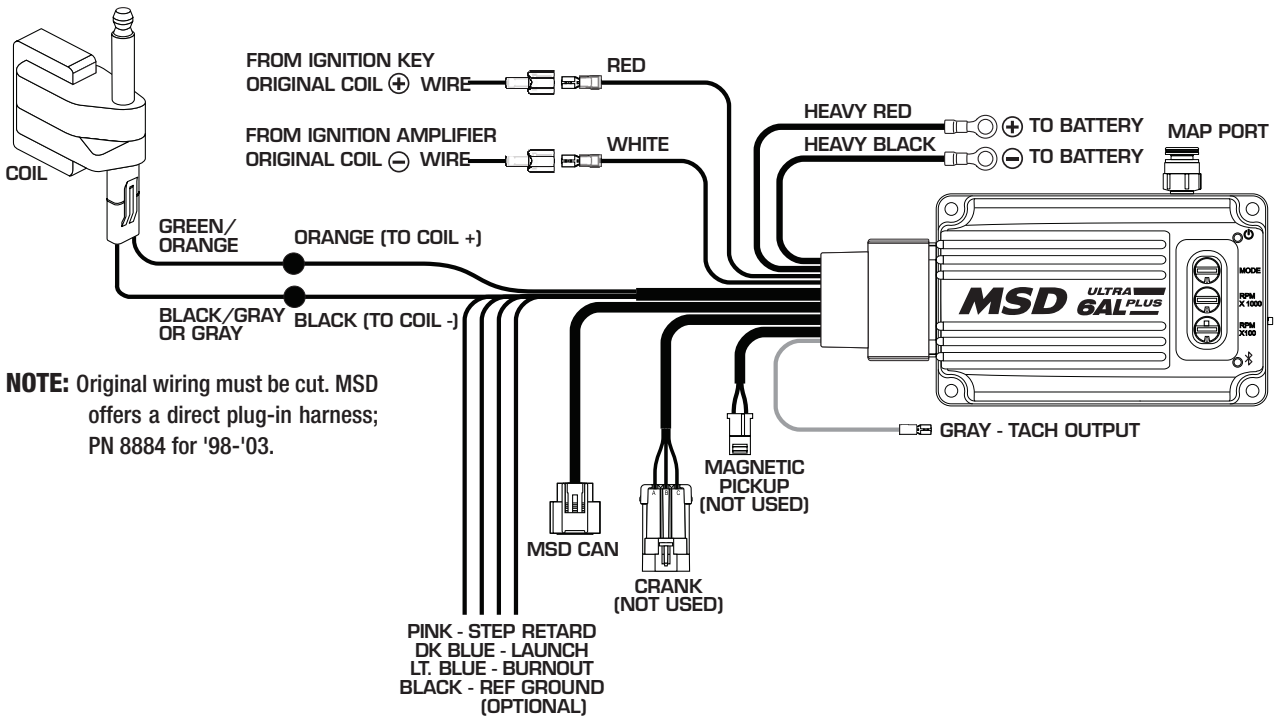

MSD SYSTEMS Wiring a Complete Dual MSD Ignition Setup.

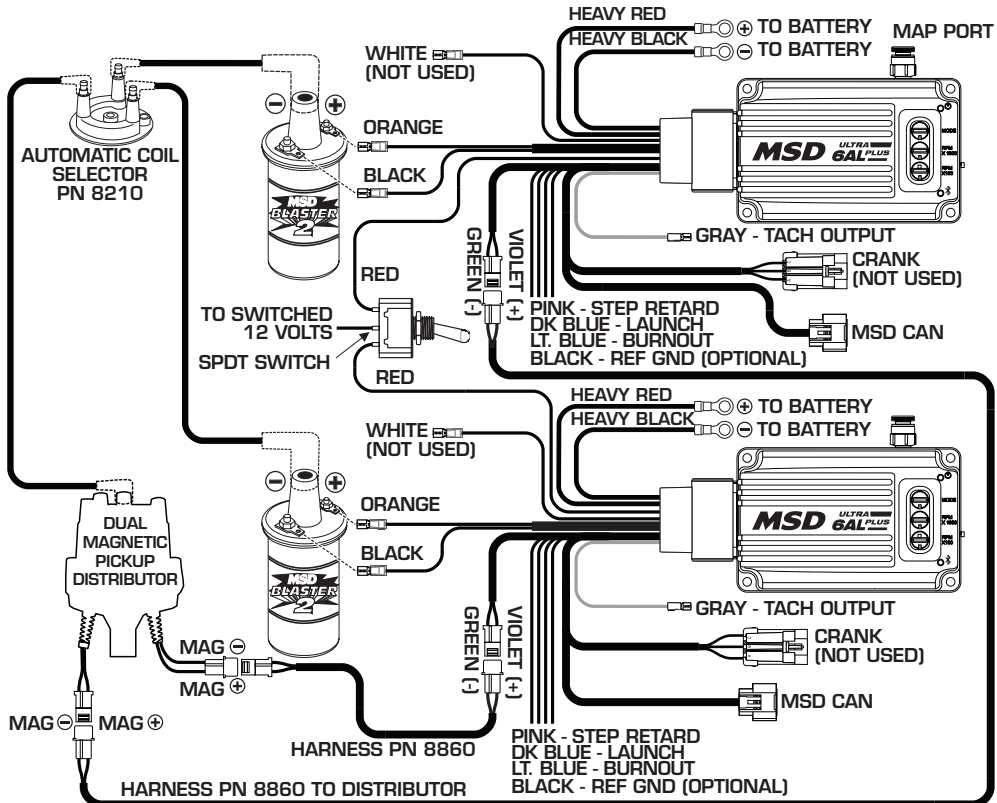

GENERAL IMPORT WIRING

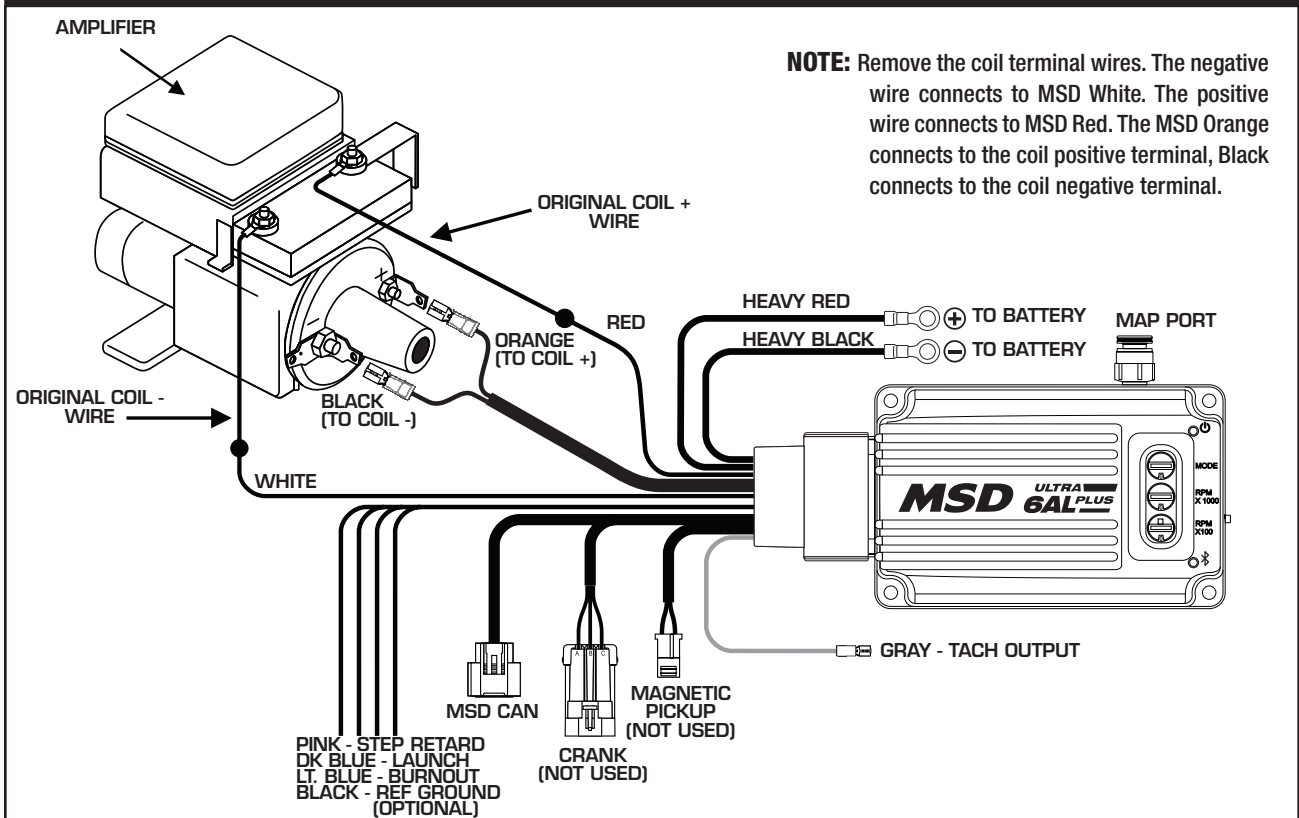

AFTERMARKET COMPONENTS Wiring a Mallory Unilite or 9000 Series using Points Trigger.

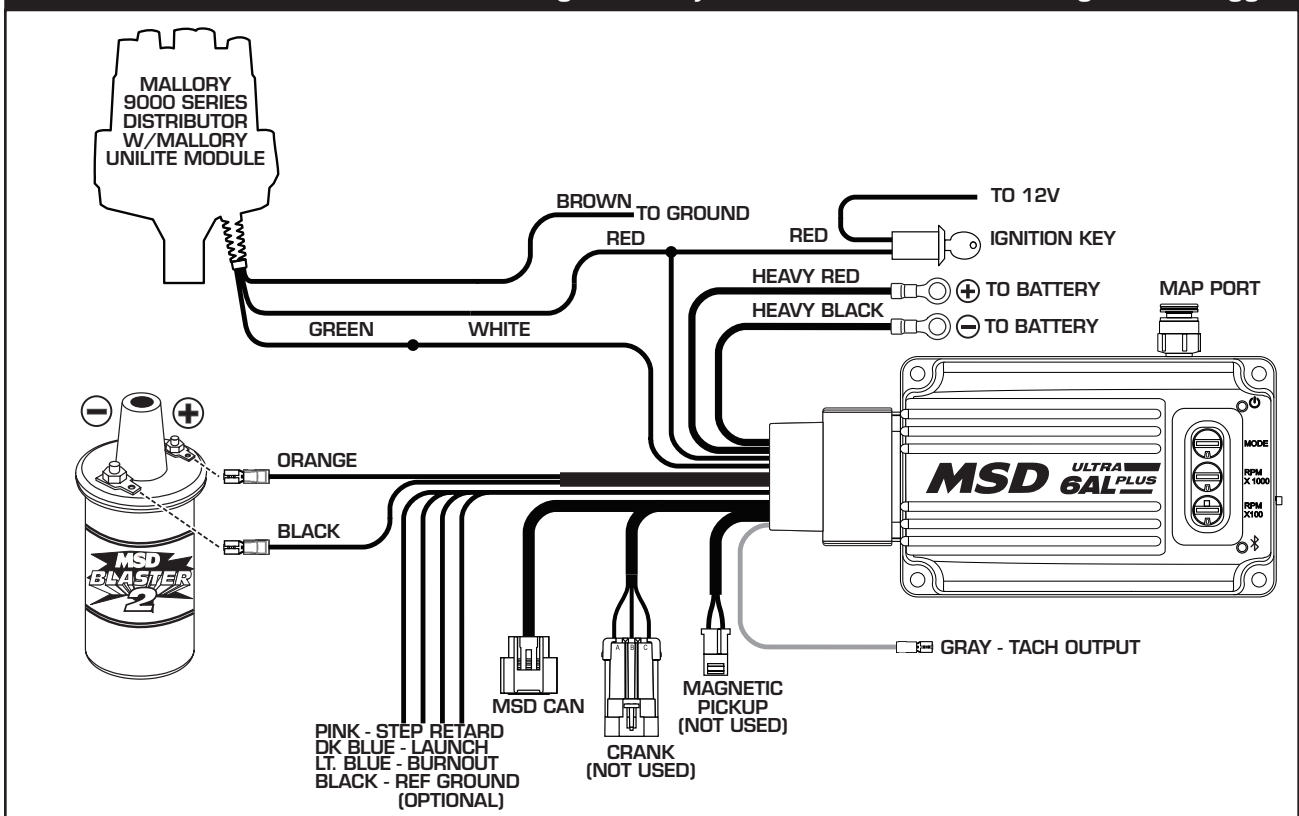

AFTERMARKET COMPONENTS Wiring a Mallory 9000 Series using Magnetic Pickup.

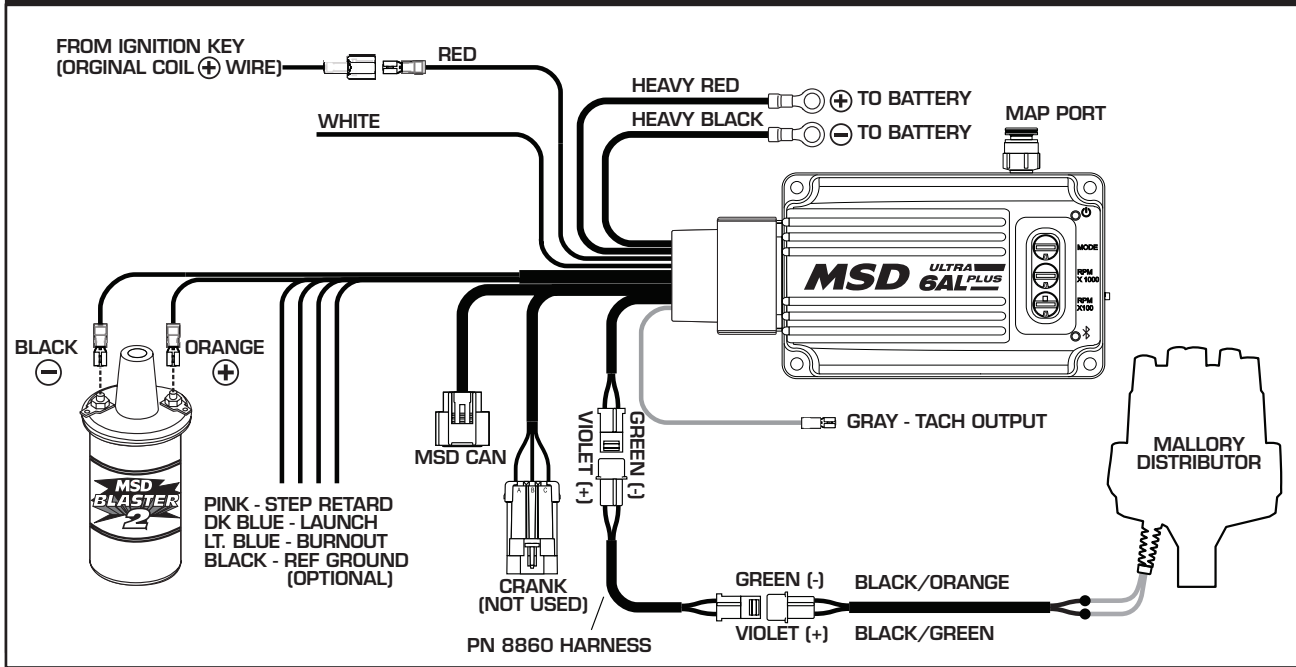

AFTERMARKET COMPONENTS Wiring to a Pertronix Ignitor Kit.

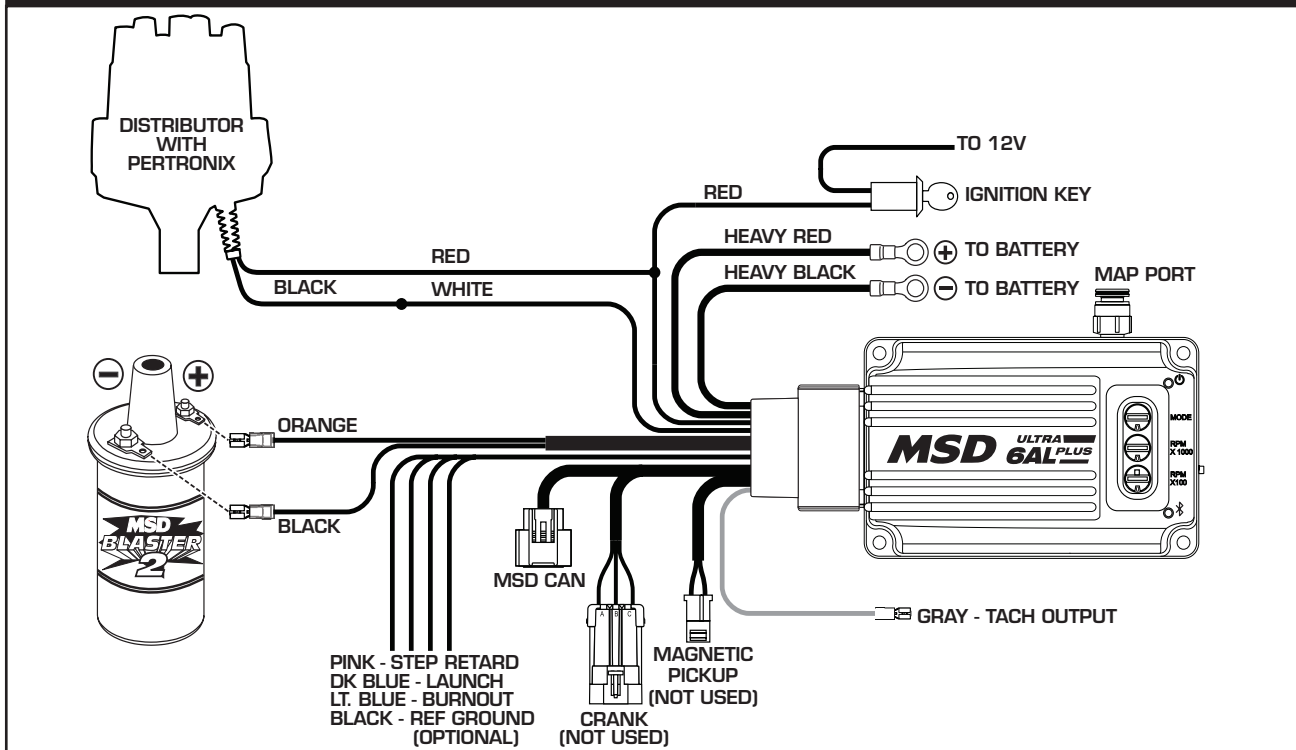

If you did not find a schematic to match your application, or if you need assistance, please contact MSD Tech at (888) 258-3835.

