



Installation Instructions

818150

2022-2026 Nisan Frontier

With 3.8L Engine

2- or 4-Wheel Drive

Crew Cab Short Bed- King Cab Long Bed



Installation requires moderate mechanical skill. If this job is beyond your abilities, seek the services of a qualified technician.

If you do not understand any part of these instructions, please call Flowmaster Technical Support at (866) 464-6553 for assistance.

Apply penetrating oil generously to clamps, fasteners, pipes, and hanger rods for ease of disassembly.

REVIEW THE INSTRUCTIONS & VERIFY THE KIT CONTENTS

Take a moment to read and understand these instructions before installing your Flowmaster exhaust kit.

ITM#	Part #	Description	Qty.
1	8525553-Z	Muffler	1
2	86748S	Left Front Inlet pipe	1
3	86749S	Left Rear Inlet Pipe	1
4	86747S	Right Inlet Pipe	1
5	26913S	Over Axle Pipe	1
6	26914S	Side Exit Pipe	1
7	ST462	Polished Tip	1
8	533HA	3" Clamp Hanger	1
9	MC300BS	3.0" Band Clamp	1
10	MC250BS	2.5" Band Clamp	3
11	HW503	1/2" Retainer	1

Use the parts drawing and list to verify your kit's contents. In the unlikely event that any parts are missing, please contact Flowmaster Technical Support for replacements.

10

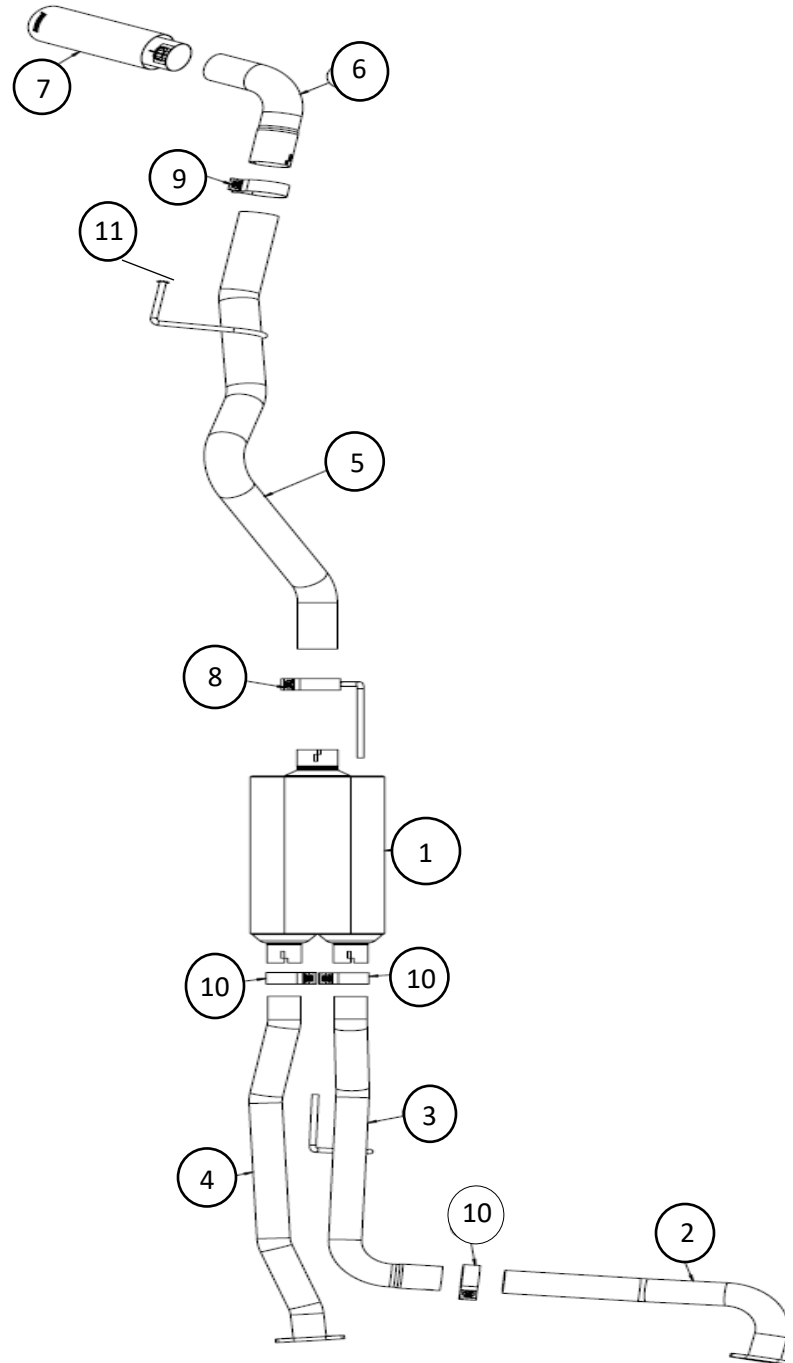

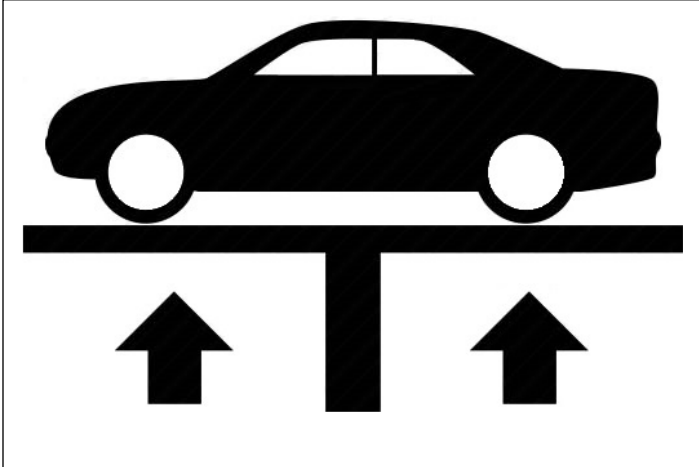

Vehicle Compatibility

Model Year: 2022-2026

Make: Nisan Frontier

Engine: 3.8L V6 (Naturally Aspirated)

- Crew Cab Short Bed
- King Cab Long Bed

Will not fit Crew Cab Long Bed (139.8" wheelbase)

BEFORE STARTING:

Raise the vehicle a minimum of 18 inches. A floor hoist is ideal. If no hoist is available, we strongly urge the use of axle stands as a safety measure.

Please read and understand these instructions and disclaimer in their entirety before attempting installation.

CAUTION! WORK ONLY ON A SOLID, LEVEL SURFACE. USE JACKS /JACK STANDS OF SUFFICIENT CAPACITY TO LIFT AND SUPPORT YOUR VEHICLE. NEVER WORK UNDER A VEHICLE SUPPORTED BY A FLOOR OR BUMPER JACK.

Removing the OEM Exhaust.

1. Apply Penetrating oil to the (x4) 14mm nuts at the inlet pipe flanges, Band clamp on the tail pipe and each rubber Hanger on the exhaust.
2. Loosen the band Clamp on the tail pipe just after the rear axle and apply penetrating oil to the slip joint.
3. Remove the M8 bolt from the tail pipe hanger assembly bolted to the frame just over the axle . **Fig.1**
4. Remove the rubber tail pipe hanger and remove the tail pipe. **Fig. 1**
5. Re install the tail pipe hanger

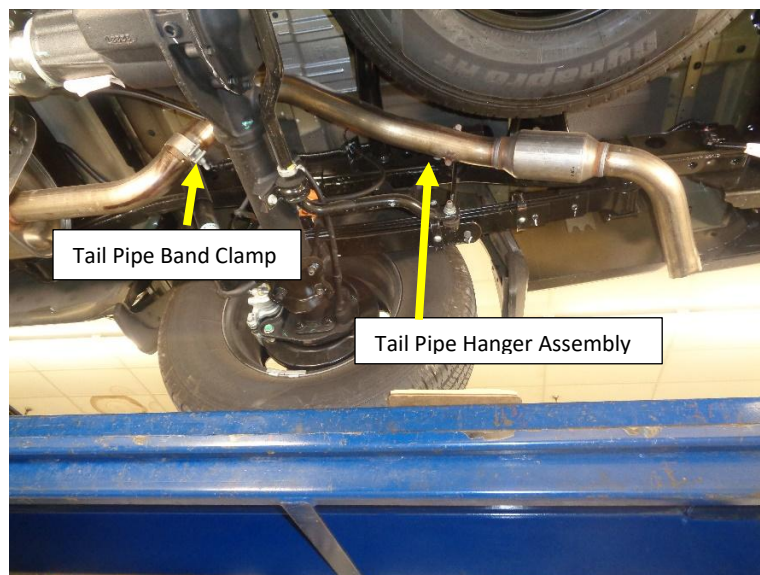

Figure.1

Removing the OEM Exhaust Cont'd

6. Remove the (x2 each) 14mm nuts at the flanges connecting the muffler inlet pipes to the catalytic converter. **Fig.2**
Note: The nuts are very tight from the factory and will require a decent quality deep socket for removal.
7. Support the muffler and inlet pipe assembly.
8. Apply Spay lube to the remaining (2) muffler hanger rods and rubber isolator.
9. Carefully Remove the inlet Pipes and Muffler assembly by sliding the assembly back towards the rear of the vehicle until the hanger rods are out of the rubber isolators. Take care not to damage the thin metal gaskets at the flanges, they will be re used later.

Caution: This assembly is heavy and awkward to manage with one person. Have a second person available to help with this process and avoid possible injury.

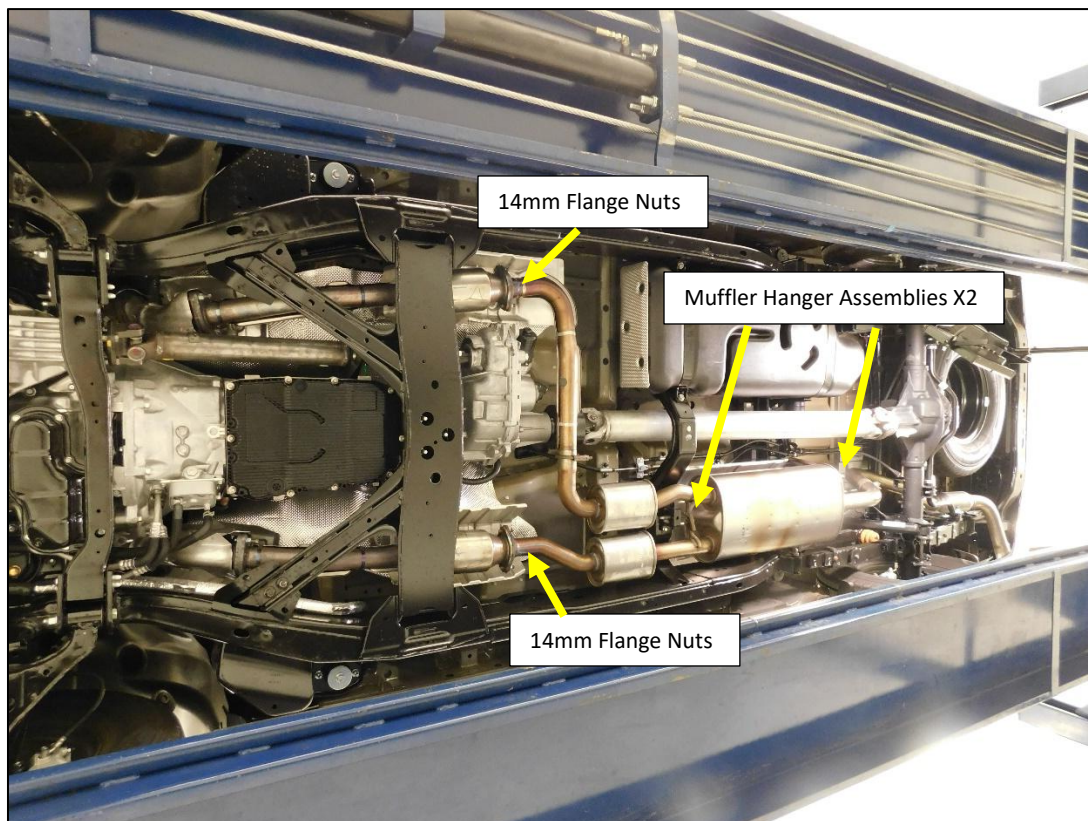

Figure.2

INSTALL YOUR FLOWMASTER EXHAUST SYSTEM



Before installing clamps in the following steps, remove their nuts, apply anti-seize compound to the bolt threads, and re-install the nuts.

1. Install the OEM metal gaskets on to the studs of the catalytic converters if removed.
2. Install the hanger rod of the left rear inlet pipe (3) into the front muffler hanger rod Isolator at the crossmember (A). Be sure to use the center round isolator hole.
3. Install a 2.5" band clamp (10) on to the expanded end of the Left Rear inlet pipe (3).
4. Install the Left Front Inlet pipe (2) into the expended end of the left rear inlet pipe (3). Align the flange to the studs on the catalytic converter. Install (x2) 14mm nuts and tighten enough to pull the flanges together but still allow for adjustment.
5. Tighten the band clamp (10) to hold the pipe but allow for adjustment.
6. Install the Right Inlet pipe (4) on to the studs of the right side catalytic converter. Install (x2) 14mm nuts and tighten enough to pull the flanges together but still allow for adjustment.

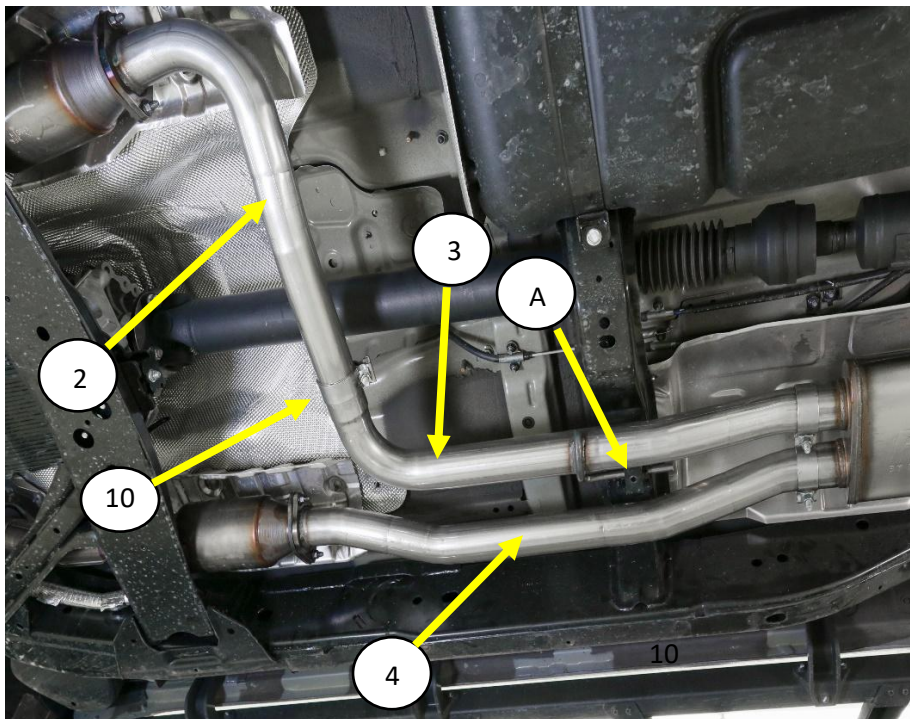

Figure.3

Installation Continued

7. Install a 2.5" band clamp **(10)** on to each muffler inlet pipe. Position with the bolts in the center and nuts facing down. **Fig.3**
8. Install the Flowmaster Muffler **(1)** on to the inlet pipes with the Flow master logo facing Down. Support the muffler from hanging on the inlet pipes. **Fig.3**
9. Install the Clamp Hanger **(8)** Straight rod into the rear muffler hanger isolator **(C)** above the muffler. Install the clamp side over the muffler outlet pipe. **Fig.4**
10. Tighten the clamps at the inlet pipes to hold the muffler in place and allow for adjustment.
11. Install the tail pipe **(5)** over the axle **Fig.5**, Install the hanger rod at the back of the tail pipe into the tail pipe hanger isolator on the frame rail. **Fig.6**
12. Install the tail pipe **(5)** into the Muffler Outlet and Tighten the clamp hanger to hold the tail pipe and allow for adjustment. **Fig.4**

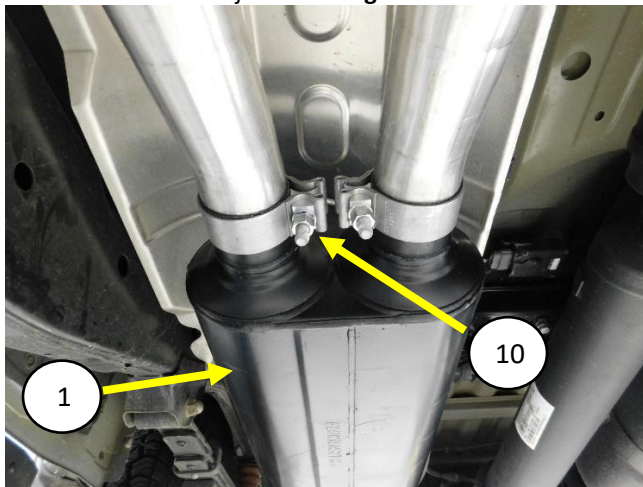

Figure. 3

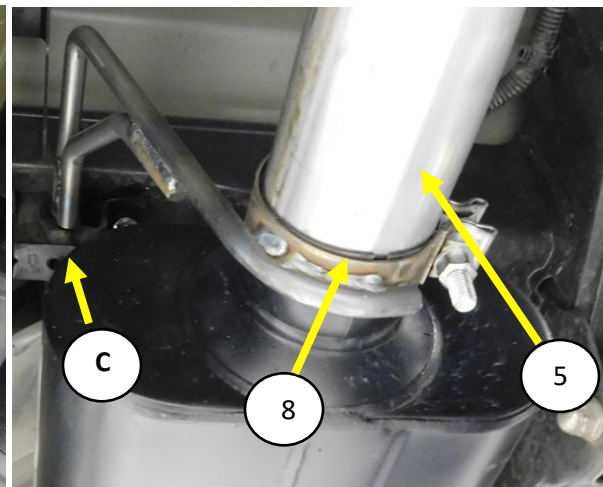

Figure.4

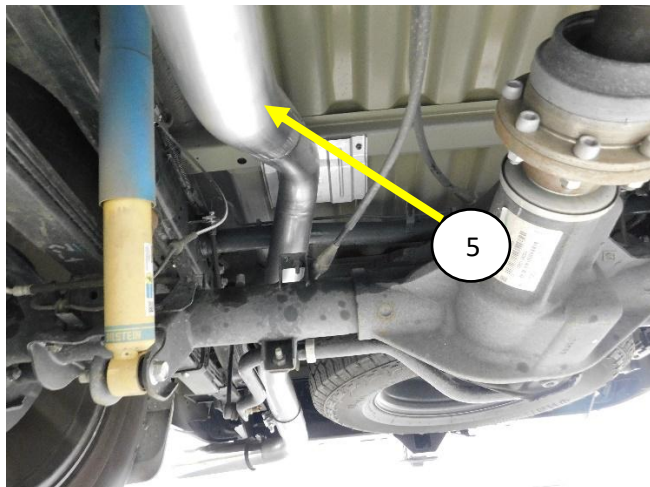

Figure.5



Figure.6

Installation Continued

13. Install the 3" band clamp (9) on to the side exit pipe (6) expanded end. Install the side exit pipe on to the tail pipe and tighten the clamp to hold the pipe in place and allow for adjustment. **Fig.7**
14. Install the Exhaust tip (7) and tighten the clamp in the desired position. **Fig.7**
15. Adjust the exhaust for the best fitment and clearance, Tighten the hardware and clamps starting at the front and work your way to the rear of the vehicle.

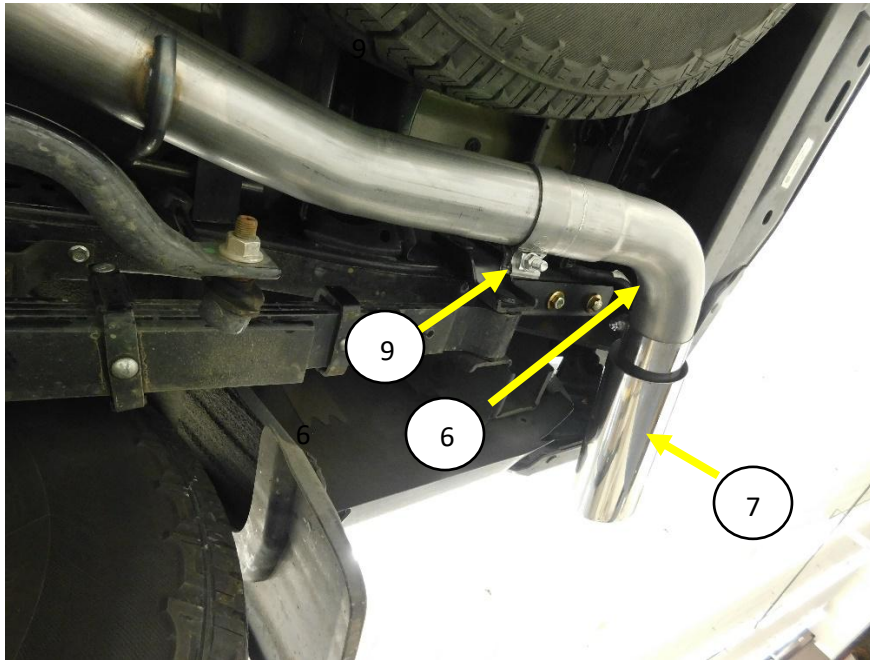

Figure.7



Enjoy Your Flowmaster Exhaust!

Enjoy Your Flowmaster Exhaust!