



Installation Instructions

818176

2024-2026 Toyota Tacoma

2.4L Turbo 4cyl

131.9 / 145.1" Wheelbase



Installation requires moderate mechanical skill. If this job is beyond your abilities, seek the services of a qualified technician.

If you do not understand any part of these instructions, please call Flowmaster Technical Support at (866) 464-6553 for assistance.

Apply penetrating oil generously to clamps, fasteners, pipes, and hanger rods for ease of disassembly.

REVIEW THE INSTRUCTIONS & VERIFY THE KIT CONTENTS

Take a moment to read and understand these instructions before installing your Flowmaster exhaust kit.

ITM#	Part #	Description	Qty.
1	26982S	Down Pipe	1
2	26983S	Muffler Inlet Pipe	1
3	26984S	Extension Pipe	1
4	8530572-Z	50 Series HD Muffler	1
5	86785S	Right Muffler Outlet Pipe	1
6	86786S	Right Tail Pipe	1
7	86788S	Left Muffler Outlet pipe	1
8	86789S	Left Tail Pipe	1
9	86787S	Rear Exit Pipe	2
10	86790S	Side exit pipe	2
11	ST339	Stainless steel tip	2
12	MC250BS	2.5" Band Clamp	6
13	MC300BS	3" Band Clamp	3
14	HA602	Tail Pipe Hanger	2
15	HW204	5/16-18 X 1" Hex Bolt	4
16	HW102	5/16 -18 Nut	4
17	HW308	5/16 Lock Washer	4
18	HW303	3/8 Flat Washer	4

Use the parts drawing and list to identify components and verify your kit's contents. In the unlikely event that any parts are missing, please contact Flowmaster Technical Support for replacements.

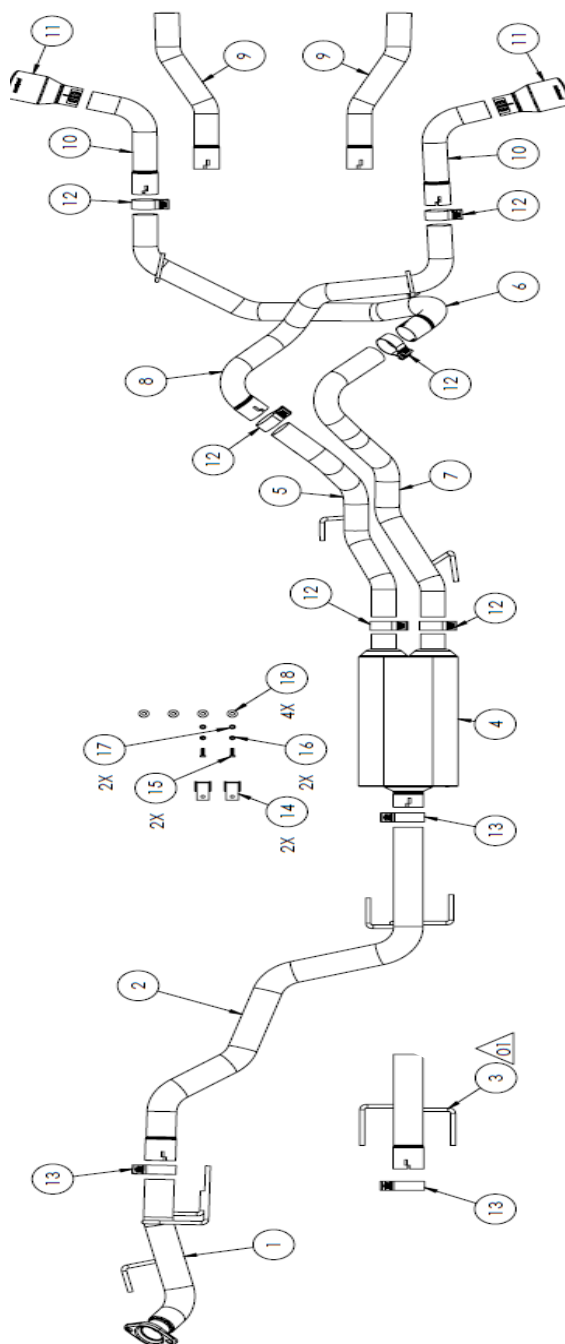

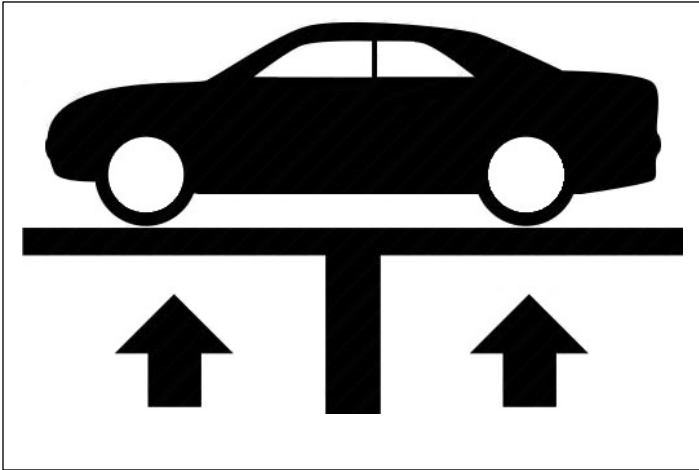

Vehicle Compatibility

Model Year: 2024-2026

Make: Toyota

Model: Tacoma

- 131.9" and 145.1" Wheelbase

Engine: 2.4L Turbo 4 cyl

- Side exit and Rear exit tail pipe configurations are included.
- Tail pipes will clear T175/90 D18 TEMPORARY SPARE ONLY
- Full size spare will not fit
- Does Not Fit leaf spring rear suspension

BEFORE STARTING:

Raise the vehicle to a minimum of eighteen inches. A floor hoist is ideal. If no hoist is available, we strongly urge the use of axle stands as a safety measure. **Please read and understand these instructions and disclaimer in their entirety before attempting installation.**

CAUTION! WORK ONLY ON A LEVEL SURFACE. USE JACKS /JACK STANDS OF SUFFICIENT CAPACITY TO LIFT AND SUPPORT YOUR VEHICLE. NEVER WORK UNDER A VEHICLE SUPPORTED BY A FLOOR OR BUMPER JACK.

Removing the OEM Exhaust:

NOTE: Please read and follow all instructions before attempting to install this exhaust system.

- The OEM muffler and inlet pipe are welded assembly and can be difficult to handle. It is recommended to have a second person available to assist with removing the OEM muffler and inlet pipe assembly.

1. Apply penetrating oil to each rubber Hanger on the exhaust.
2. Support the muffler before disassembly or removing any rubber hangers.
3. **Lifting the vehicle to full rear suspension drop or removing the spare tire will be necessary to remove the OEM Tail pipe from the vehicle.**
4. Remove the (2x) 14mm nuts from the tail pipe flange connection (A) just after the OEM muffler. Remove the Rubber hanger isolators (B) from the hanger rods and remove the OEM tail pipe. **Fig.1**
5. Remove the spring bolts at the flanged connection between the down pipe and the muffler inlet pipe(C). **Fig.2**
6. Remove the rubber isolators (D) from the muffler hanger rods then remove the muffler assembly. **Fig.1/2**
7. Remove the spring bolts from the flanged connection between the catalytic converter and the down pipe (E), remove the rubber isolators (F) and remove the down pipe. **Fig.2**

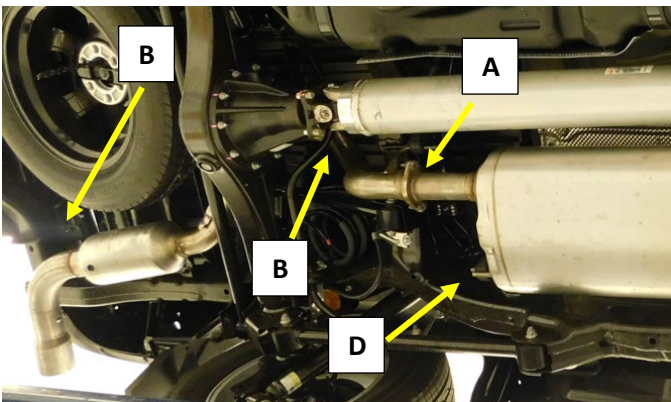

Figure.1

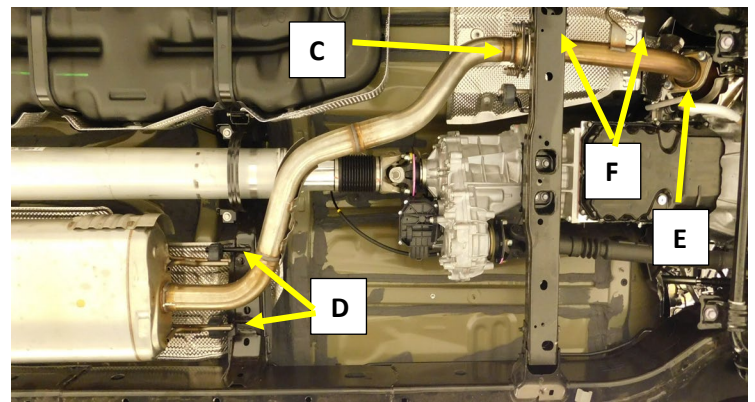

Figure.2

Installing your 818176 Flowmaster Exhaust

1. Install the supplied Down Pipe (1) on to the catalytic converter using the OEM spring bolts. **Fig.3**

Important: Start the bolts by hand using a 6" extension and a ratchet, DO NOT use an impact driver. Be sure the bolts start in the threads easily and do not force the issue if it feels bound or cross threaded. Keep positive pressure on the spring as the bolt is threaded into the nut on the catalytic converter flange. Start both bolts several threads before tightening them evenly until the bolt shoulder passes through the downpipe flange and seats on the flange of the catalytic converter.

*The flange should not be tight on the gasket when the bolts are tightened. This is designed to be a floating connection with the spring pressure maintaining the flange to gasket seal. **If the flange does not move, something is wrong!**

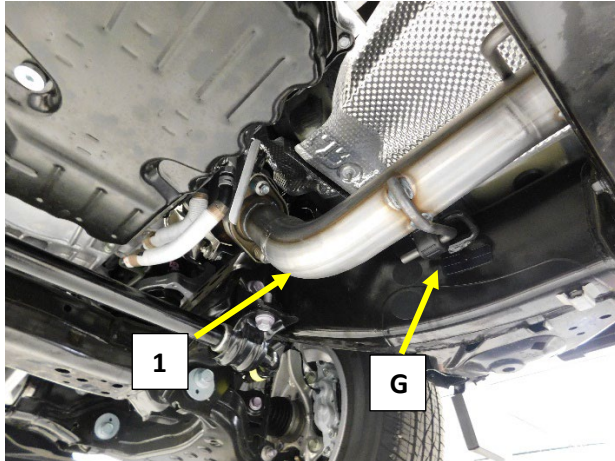

Figure.3

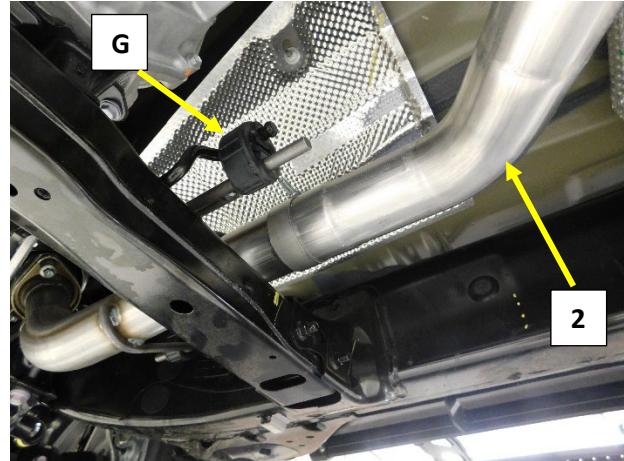

Figure.4

2. Install the rubber Isolators (G) on to the hanger rods. **Fig.3/4**
3. Install a 3" band clamp (13) into the inlet (expanded section) of the Muffer inlet pipe (2). Position the clamp with the bolt at the top of the expanded section and the nut facing the transmission. **Fig.4/5**

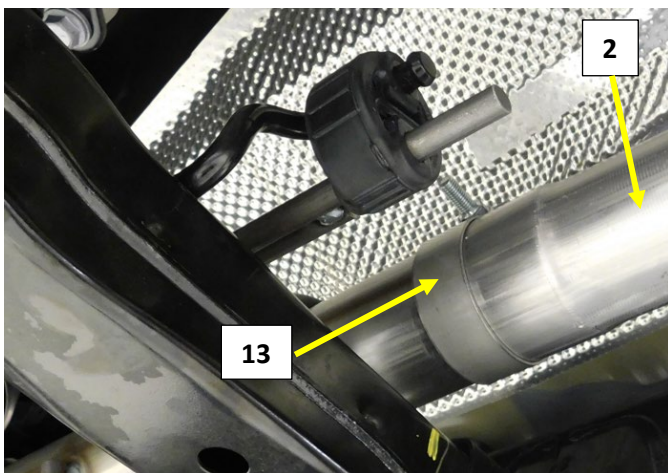

Figure.5

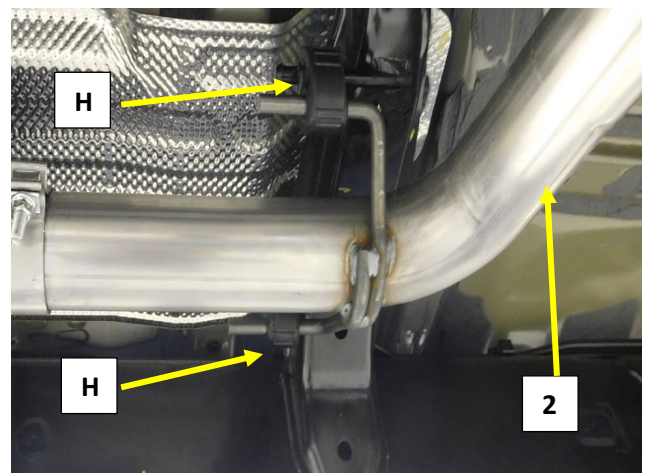

Figure.6

4. Install the muffer inlet pipe (2) on to the down pipe (1), align the hanger rods with the frame hangers and install the rubber isolators. **Fig.4/5/6**

Installing your 818176 Flowmaster Exhaust

5. Install a 3" band clamp (13) on to the inlet of the 8530572-Z muffler (4). **Fig. 7**
6. Install the muffler (4) on to the muffler inlet pipe (2), align the muffler with the logo down and muffler case level. Tighten the clamp. **Fig. 7** **Note: Use extension pipe 26984S (3) between Muffler and inlet pipe**
7. Install a supplied 2.5" band clamp (12) on each muffler outlet. **Fig. 7**

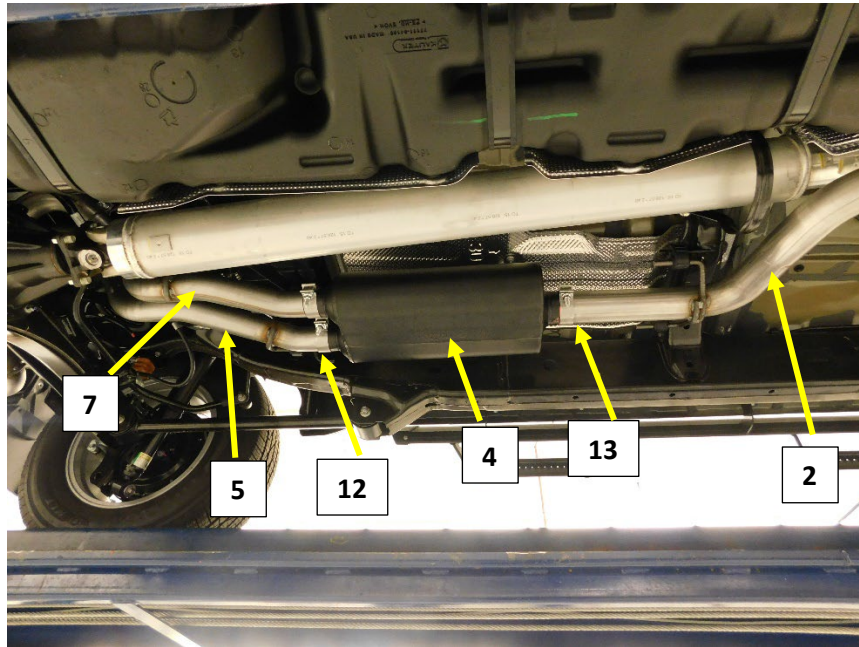

Figure.7

8. Install the Left Muffler Outlet Pipe (5) into the mufflers left (drivers side) outlet. Install the rubber isolator on to the hanger rod and frame hanger. Rotate the outlet pipe to a $\frac{1}{2}$ to $\frac{3}{4}$ " clearance on the upper 4 link bar. Tighten the clamp just enough to prevent movement. **Fig.8**
9. Install the Right Muffler Outlet Pipe (7) into the mufflers right (passenger side) outlet. **Fig.7**. Rotate the pipe up and install the rubber isolator on to the hanger rod and frame hanger. Adjust the clearance between the two pipes to $\frac{1}{2}$ " just after the bend up into the chassis. Tighten the clamp just enough to prevent movement. **Fig.9**

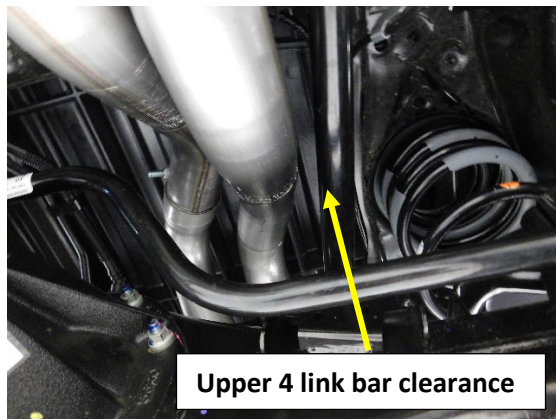

Figure.8

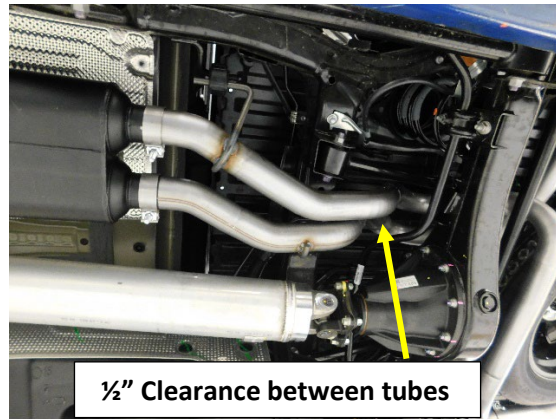

Figure.9

Installing tail pipes and frame hangers

1. Remove the plastic plugs from the rear frame rail access holes just behind the rear tires. **Fig.10**
2. Install a flat washer on to the Supplied 5/16 x 1" bolt.
3. Install the bolt and washer through the access hole and into the square hole in the bottom of the frame rail just below the access hole. This is best accomplished with a small telescoping magnet or magnetic screwdriver that will hold the bolt and washer as they are installed into the frame rail. **Fig.11/12**



Figure.10



Figure.11



Figure.12

Note: The tail pipes will exit on opposite sides of the vehicle from how they exit the muffler. The right tailpipe connects to the left muffler outlet pipe and the left tail pipe will connect to the right Muffler outlet pipe.

10. Install a 2.5" band clamp (**12**) on to the left tail pipe (**8**). Position the clamp with the bolt at the top of the pipe and the nut facing the right frame rail when the tube is installed on to the right muffler outlet pipe (**5**). **Fig.13**
11. Install the left tail pipe (**8**) expanded end with clamp installed over the axle and onto the right muffler outlet pipe (**5**) just over the differential. **Fig.13**
12. Install a supplied tail pipe frame hanger (**14**) on to the left tail pipe (**8**) hanger rod. Rotate the tail pipe up and position the frame hanger on to the bolt installed into the frame rail and install a flat washer, lock washer and nut. Use the magnet or screwdriver to help hold the bolt as the washers and nut are installed. **Fig.14**

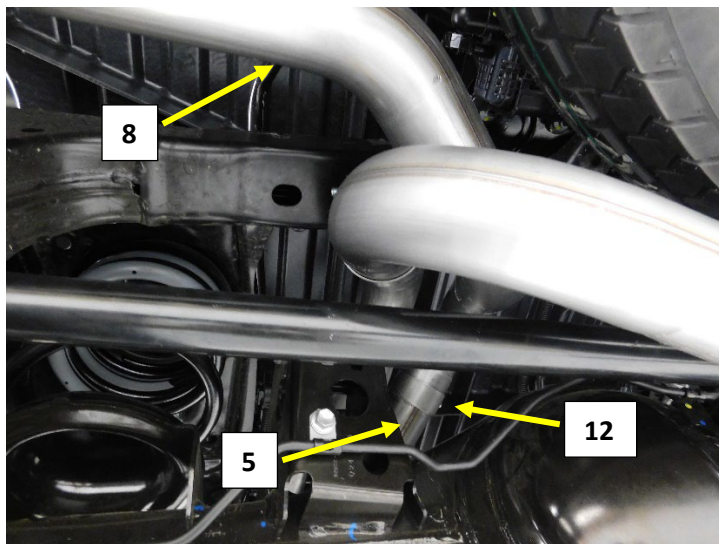

Figure.13

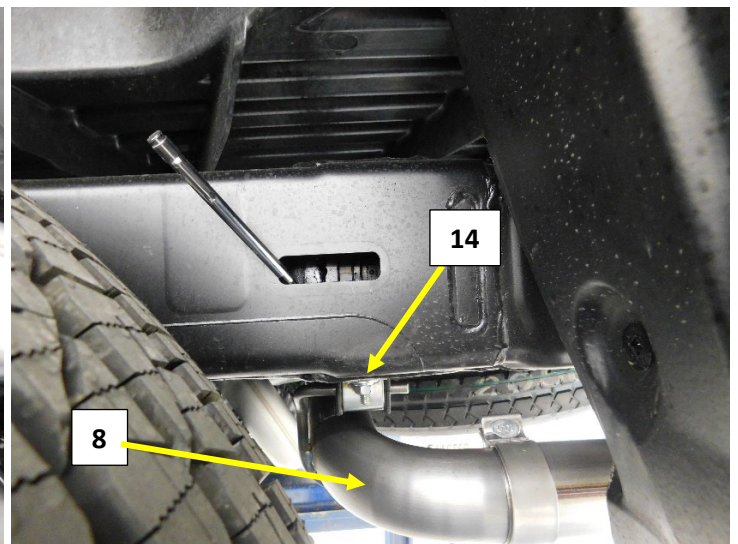

Figure.14

Installing tail pipes and frame hangers

13. Install a 2.5" band clamp (12) on to the expanded end of the right tail pipe (6). Position the clamp with the bolt at the top of the pipe and the nut facing the left frame rail when installed on to the left muffler outlet pipe. **Fig.14**
14. Install the right tail pipe expanded end on to the left muffler outlet pipe just over the pan hard bar and upper 4 link bracket. position the clamp for best clearance and tighten to allow adjustment but keep the clamp in place while the tail pipe is fully installed. **Fig.14**
15. Install a supplied tail pipe frame hanger (14) on to the left tail pipe hanger rod. Rotate the tail pipe up and position the frame hanger on to the bolt installed into the frame rail and install a flat washer, lock washer and nut. Use the magnet or screwdriver in place to help hold the bolt as the washers and nut are installed. **Fig.15**

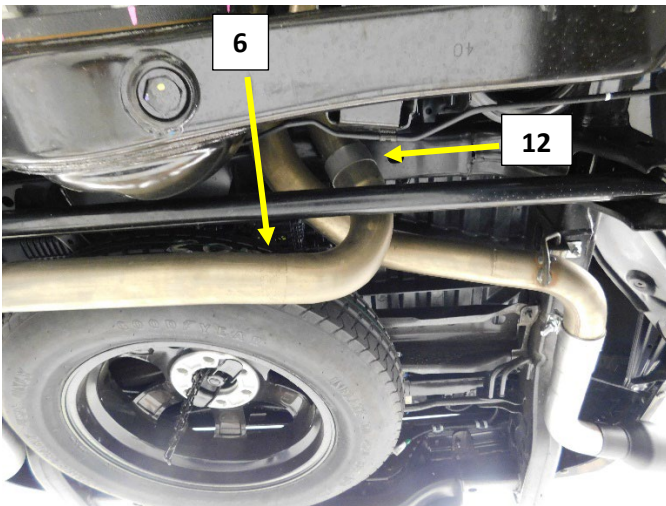

Figure.14

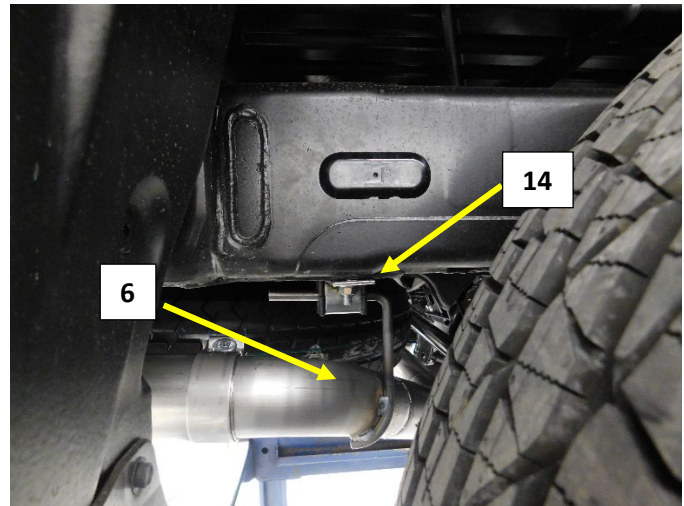

Figure.15

16. Install a 2.5" band clamp on to either the Rear Exit (9) or Side Exit (10) tail pipe extensions. Install the extension pipe on to the tail pipe and tighten the clamp to allow for adjustment.
17. Install the ST339 (11) polished stainless steel tips on to the tail pipe extensions. Adjust the extension pipe for desired position and tighten the clamp.
18. Adjust the tips and tighten the clamp bolts
19. Start at the front of the exhaust and adjust the components for best alignment and component clearance. Tighten the clamps as you go.
20. Loosen the spare tire and pull it toward the trailer hitch as far as it will go for maximum clearance around the tail pipes and tighten the hold down. **Note: Only temporary size T175/90D18 spare is compatible with this exhaust.**



Enjoy Your Flowmaster Exhaust!