

# INSTALLATION GUIDE

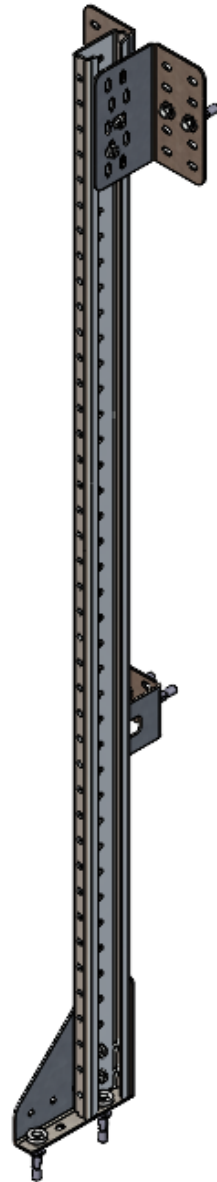

## 84-U0063 Fold-Away post with foot

Fold-away post with foot are packaged separately.



Scan the QR for the latest Install-Guide.





# BEFORE YOU BEGIN

READ, UNDERSTAND, AND FOLLOW ALL WARNINGS AND INSTRUCTIONS BEFORE USING THIS PRODUCT. FAILURE TO FOLLOW THESE DIRECTIONS MAY RESULT IN PROPERTY DAMAGE, SERIOUS BODILY INJURY, AND/OR DEATH. RANGER DESIGN IS NOT RESPONSIBLE FOR ANY PROPERTY DAMAGE, PERSONAL INJURY, OR DEATH THAT OCCURRED WHILE USING ANY RANGER DESIGN PRODUCTS.



## WARNING

- Failure to use Ranger Design-provided fasteners, brackets, and proper installation guidelines could increase risk of serious personal injury and/or death.
- If drilling is required to complete this installation: improper drilling can cause property damage to vehicles and could lead to electric shock, fire, or even death.
- If drilling is required to complete this installation: Ensure that drilling is only performed on areas of the vehicle allowed by the vehicle's Original Equipment Manufacturer's Body Builders Layout Book (or equivalent document).
- Prior to installation, inspect the vehicle to ensure that installation will not interfere with, or cause obstruction of, any critical components such as electrical wiring, fuel tanks, fuel-cells, locks, latches, etc.
- The installer or manufacturer is responsible for ensuring anchorages are installed onto suitable wall and floor structures; wall and floor strength must meet applicable performance requirements.
- Do not install systems into any weak or unsound materials such as plastics, woods, thin-walled metals, etc. without proper reinforcement.
- Do not install this product where it could interfere with the deployment of airbags. Failure to comply could result in death or serious injury.
- Do not install this product where it could ingress on the Transit Occupant Protection Zone. Failure to comply could result in death or serious injury.
- Incorrect installation could cause water leaks, electric shock or fire.
- Any cargo vehicle with any cargo or equipment should use a certified partition. See Ranger Design website for some partition options. (<https://rangerdesign.com/>)
- Mountings rails are recommended for any attachment to the vehicle walls.
- All items in the cargo area should be properly secured and partition doors closed while the vehicle is in motion.
- Check your vehicle's tare weight and remaining load capacity with all the equipment installed. Never exceed the maximum Gross Vehicle Weight Rating (GVWR), Gross Axle Weight Ratings (GAWRs), or other maximum loads permitted by the vehicle's Original Equipment Manufacturer (OEM) and required by law.
- The heaviest items must be placed towards the bottom of the vehicle, while the lightest ones can be arranged upwards. Vehicle cargo loading weight proportion should follow the following guidelines:



- The final alterer and/ or modifier should review the warning sheet with the customer before the vehicle is released to the customer or for general use. These instructions should remain with the vehicles a all times.
- Any modification or unintended use of this product voids any warranty and could create a hazardous condition.
- Ranger Design provides recommended assembly and installation instructions which should be followed to ensure correct operation. Failure to do so could result in invalidating the product's compliance, warranty and cause injury. Notwithstanding, the final stage vehicle alterer and/or modifier is responsible for the integration, installation, and compliance of the product in its final location to all applicable regulations and standards. Failure to maintain compliance of the vehicle to applicable regulations and standards could be punishable by law. Alterers and/or modifiers should consult with all local authorities prior to commissioning.



## CAUTION

- Drilling is required to complete this installation. Before drilling, ensure that you will not hit any critical parts of the vehicle like the gas tank, wiring harness, or hose. Consult the vehicle OEM documentation as necessary. When drilling, use a drill collar to reduce the risk of damage to the vehicle.
- Any materials, padding, or glazing installed in the vehicle must comply with FMVSS/CMVSS 201/205/302, as applicable.
- In the event of a motor vehicle accident or collision where a Ranger system has been installed, especially ones where the vehicle structure is damaged and/or the air bags deploy and/or the vehicle has been towed, the system must be inspected to ensure continued soundness and safety before returning the vehicle to service. Damaged components should be replaced as necessary.
- All system components should be regularly inspected, cleaned, and maintained pursuant to Ranger guidelines.

# QUICK START GUIDE

## Phase 1 - Assembly

<input type="checkbox"/> 1.1 Setup.....	4
<input type="checkbox"/> 1.2 Post Assembly.....	6

## Phase 2 - Installation

<input type="checkbox"/> 2.1 Attach Wall Bracket To The Posts.....	9
<input type="checkbox"/> 2.2 Mark Hole For Plusnut.....	10
<input type="checkbox"/> 2.3 Attach Plusnut.....	11
<input type="checkbox"/> 2.4 Fold-Away Installation.....	13

# REQUIRED ITEMS

- Cordless Impact
- Cordless Drill
- Tape Measure
- Marker
- 1/2" Socket
- 1/2" Drill Bit w/ Drill Collar ( Set at 1/2" )
- 3/8" Driver Bit
- Knife
- Plusnut Tool / Plusnut Gun ( 5/16" )

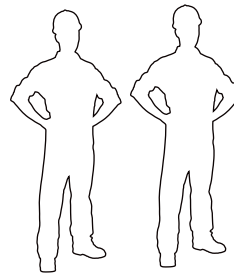

**2**  
**PERSONS**

# PHASE 1 – ASSEMBLY

## 1.1 SETUP

1.1.1 Unpack components; compare with the bill of materials.

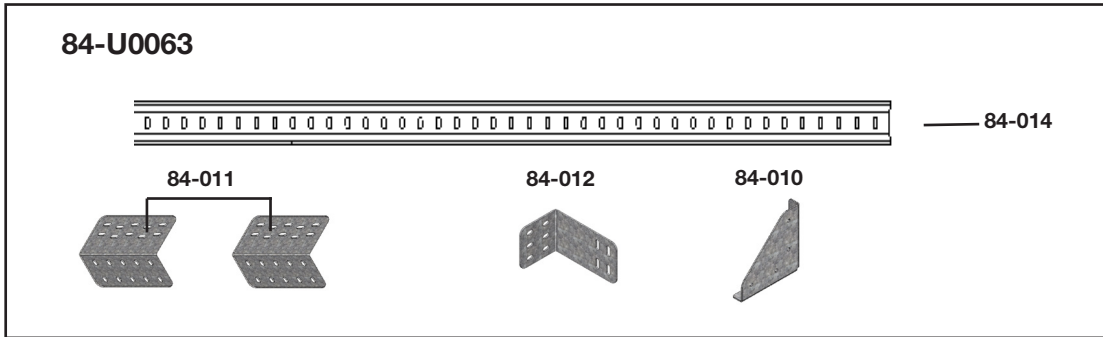

1.1.2 Verify all parts are present.

Item No.	Description	Qty.
84-010	Feet	1
84-011	Top Bracket	2
84-012	Middle Bracket	1
84-014	Post ( 63" )	1
94-3057	Assembly Fastener Kit	1
96-3039	Install Fastener Kit	1



**94-3057**







**Fastener Assembly**

- 6x  # 90-204 Hex Bolt  
5/16"-18 x 3/4"  
GR-5 ZINC
- 2x  # 90-224 Hex Bolt  
5/16"-18 x 2"  
GR-5 ZINC
- 8x  # 98-116 Flat Washer  
5/16"  
ZINC
- 8x  # 94-116 Serrated Nut  
5/16"-18  
ZINC
- 8x  # 98-170 Spacer  
NYLON

**6x**

-  #90-204 Hex Bolt 5/16" x 3/4"
-  #98-116 Flat Washer
-  #94-116 Serrated Nut

**2x**

-  #90-224 Hex Bolt 5/16" x 2"
-  #98-116 Flat Washer
-  #98-170 Spacer
-  #94-116 Serrated Nut

**96-3039**

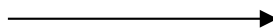





**Fastener Assembly**

- 6x  # 90-212 Hex Bolt  
5/16"-18 x 1 - 1/4"  
GR-5 ZINC
- 2x  # 90-011 Hex Bolt  
5/16"-18 x 1 - 3/4"  
GR-5 ZINC
- 8x  # 98-116 Flat Washer  
5/16"  
ZINC
- 8x  # 98-122 Lock Washer  
5/16"  
ZINC
- 8x  # 94-132 Plusnut  
5/16"
- 6x  # 98-157 Spacer  
0.375" ID, x 1.0" OD x 0.25" L  
NYLON

**6x**

-  #90-212 Hex Bolt 5/16" x 1-1/4"
-  #98-122 Lock Washer
-  #98-116 Flat Washer
-  #94-132 Plusnut

**2x**

-  #90-011 Hex Bolt 5/16" x 1-3/4"
-  #98-122 Lock Washer
-  #98-116 Flat Washer
-  #98-157 Spacers  
( QTY = GAP BETWEEN FLOOR AND END PANEL )
-  #94-132 5/16" Plusnut

# PHASE 1 – ASSEMBLY

## 1.2 POST ASSEMBLY

1.2.3 Attach the foot to the post.

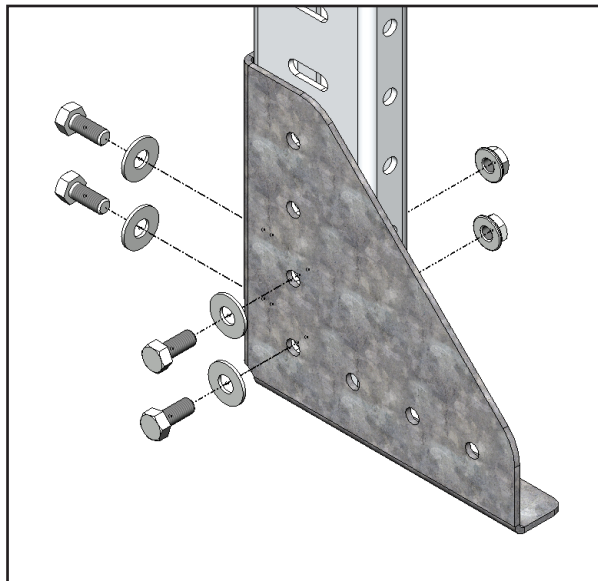
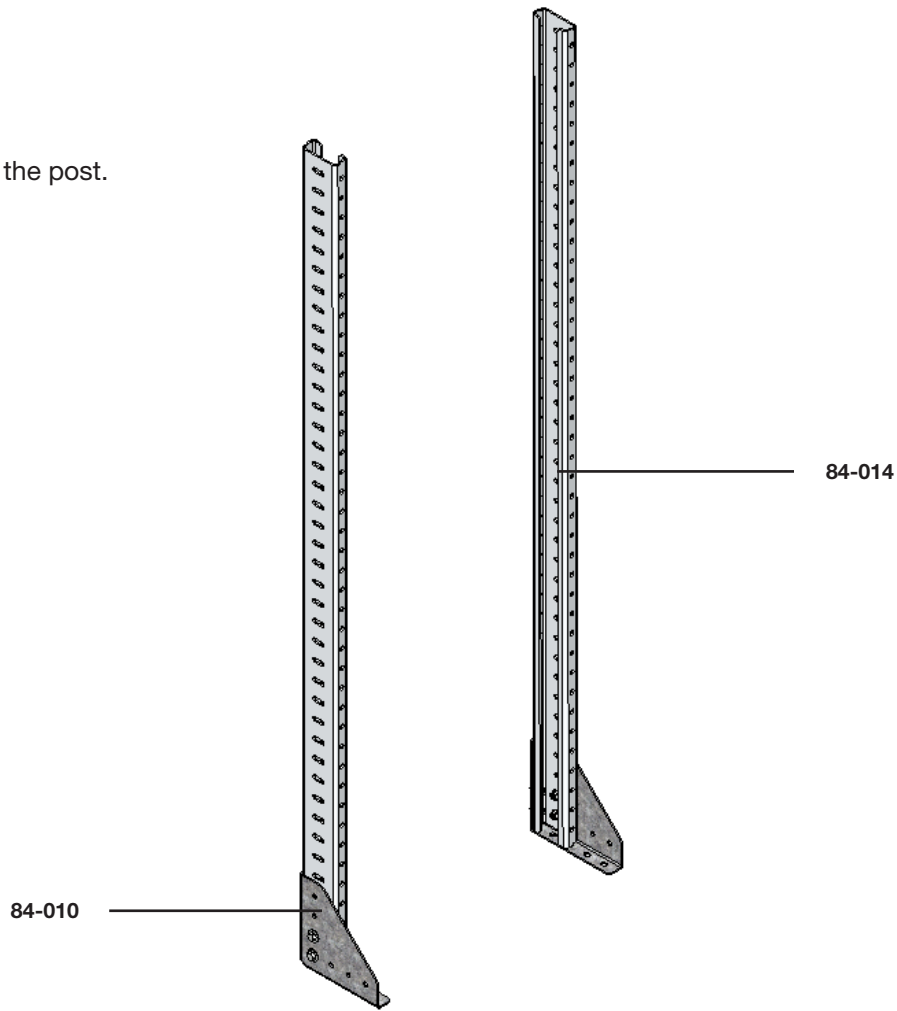



### TOOLS

- Cordless Impact
- 1/2" Socket

### HARDWARE USED

4x

- |  |                               |
|--|-------------------------------|
|  | #90-204 Hex Bolt 5/16" x 3/4" |
|  | #98-116 Flat Washer           |
|  | #94-116 Serrated Nut          |

**1.2.4** Attach 2 threaded plates to each post.

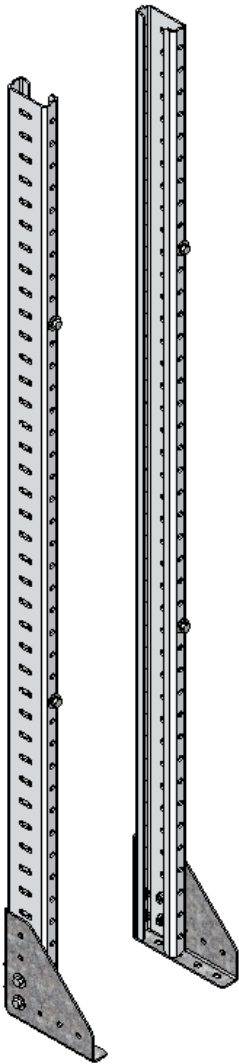



**TC**

- Cordless Impact
- 1/2" Socket

**HARDWARE USED**

**4x**

	#90-204 Hex Bolt 5/16" x 3/4"
	#98-122 Lock Washer
	#98-116 Flat Washer

• Note: Threaded plates are packaged together with the fold-away shelves.

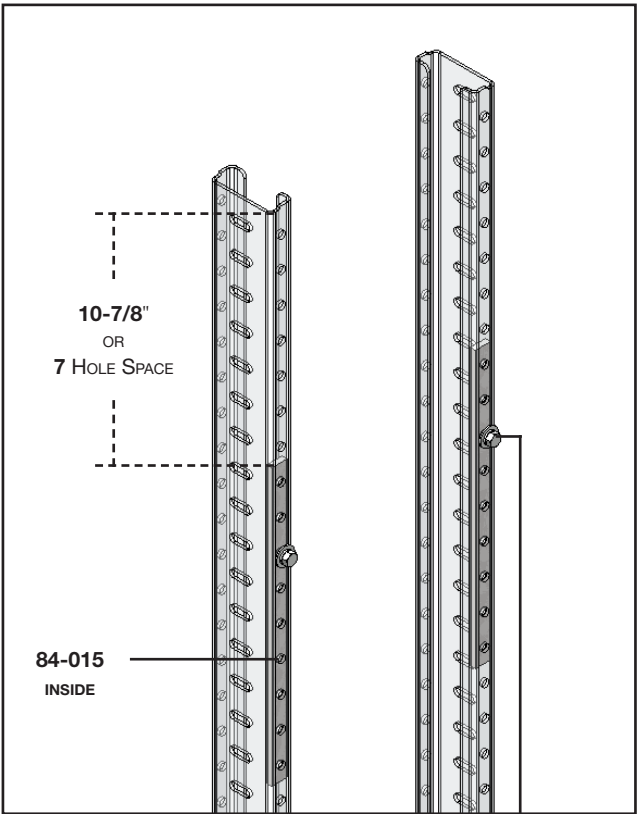

3<sup>RD</sup> HOLE OF THREADED PLATE FROM THE TOP

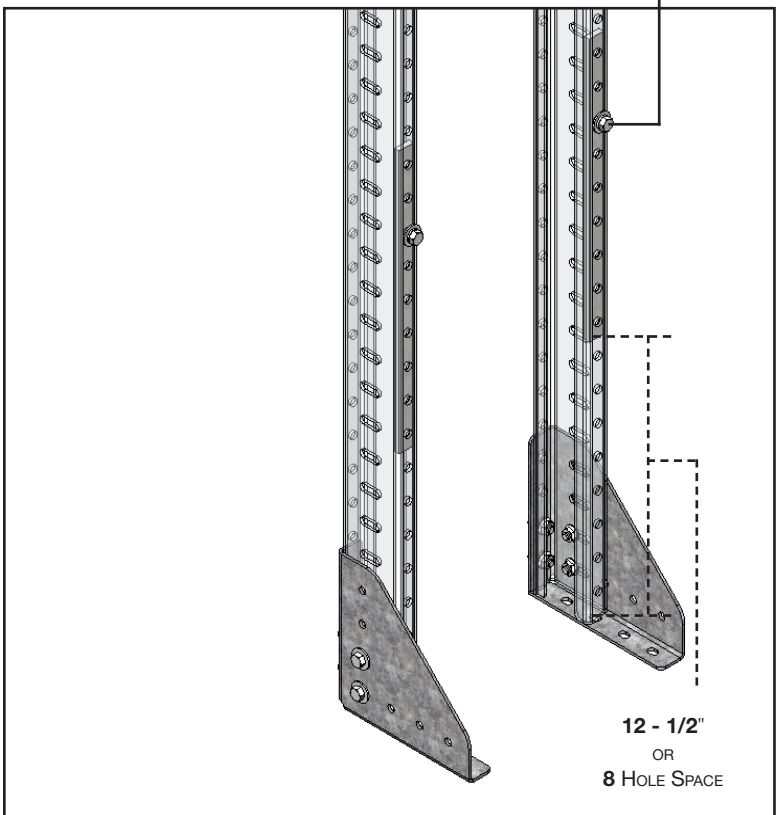

1.2.5 Attach the shelf trays to the posts.

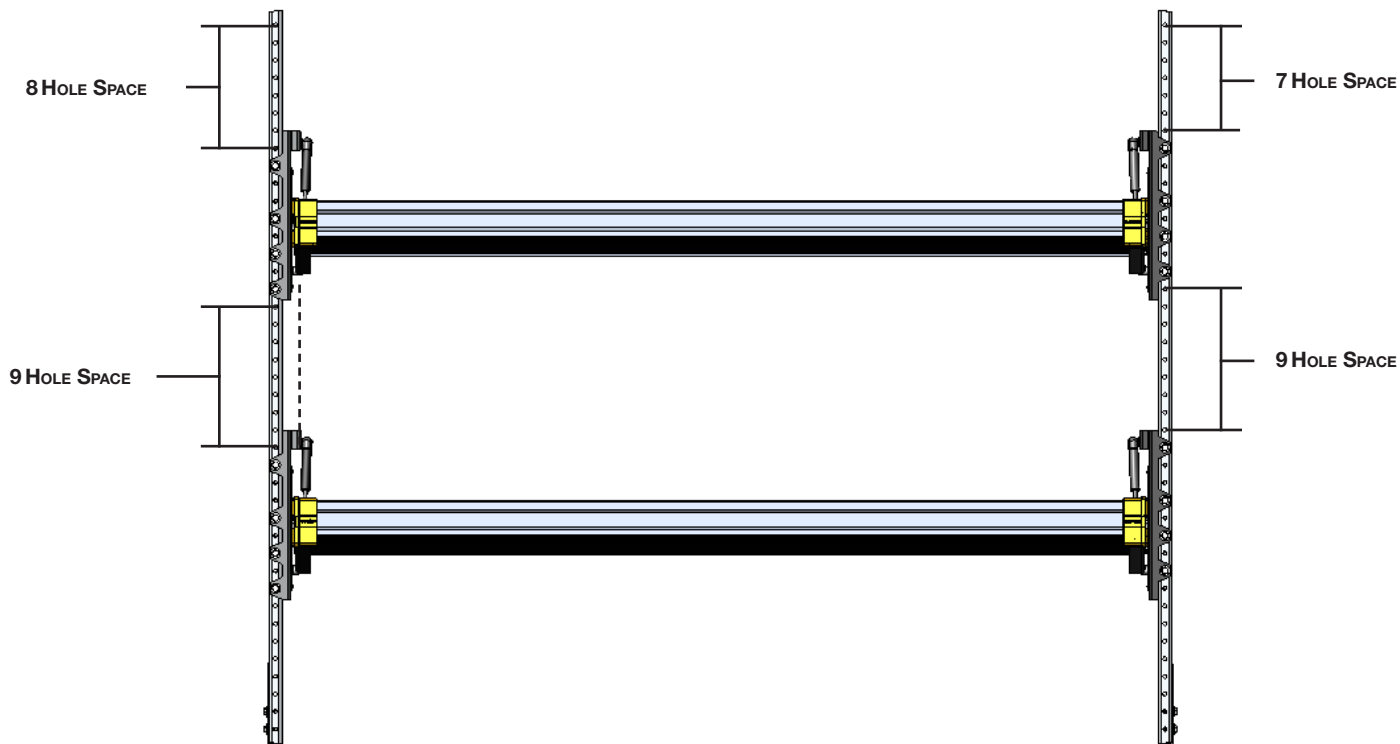

• Please note that 96-3038 hardware is included inside the box of 84-U1830.

**TOOLS**

- Cordless Impact
- 1/2" Socket

**HARDWARE USED**

**16x**

- #90-204 Hex Bolt 5/16" x 3/4"
- #98-122 Lock Washer
- #98-116 Flat Washer

# PHASE 2 – INSTALLATION

## 2.1 ATTACH WALL BRACKETS TO THE POSTS

- 2.1.1 • Lift the assembled fold-away to the vehicle, then put it in place.  
 • Attach the top and middle bracket to the posts.

**NOTE:** Make sure that the posts stand vertical.

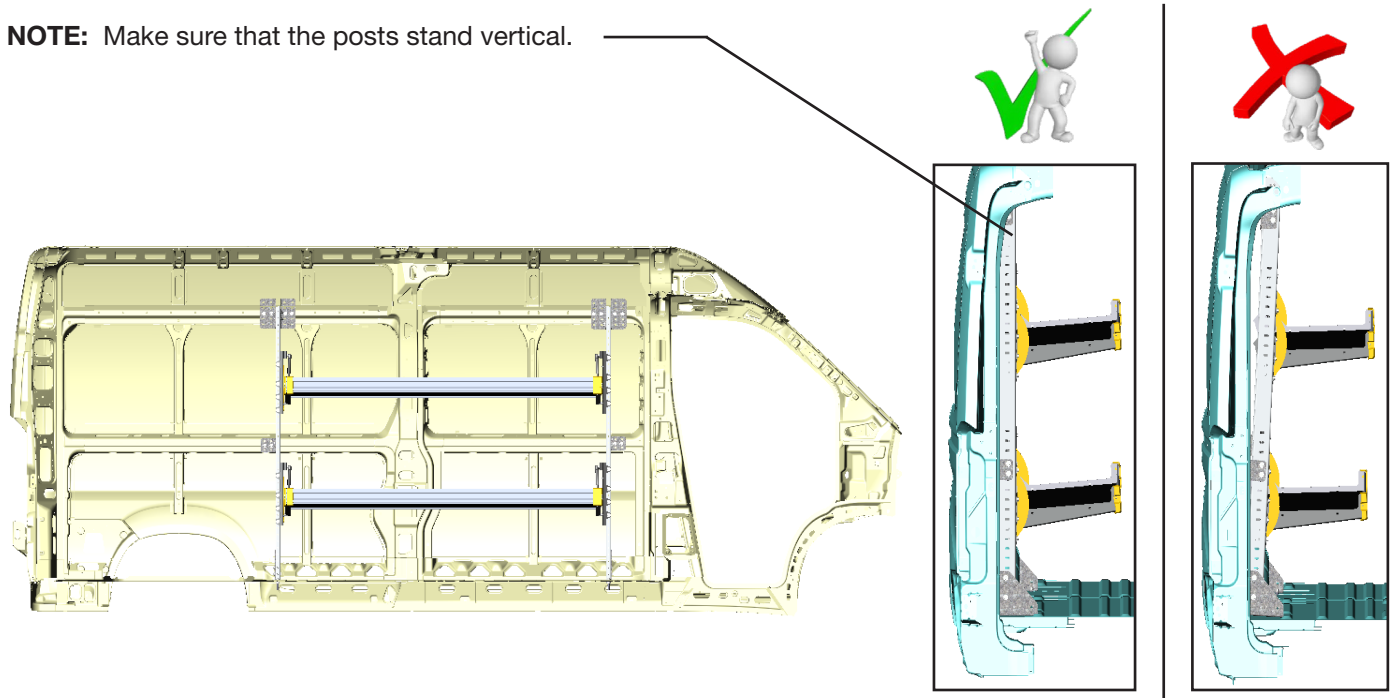

HORIZONTAL RAIL

84-011

84-012

**TOOLS**

- ☐ Cordless Impact
- ☐ 1/2" Socket

**HARDWARE USED**

**4x FOR TOP BRACKET**

#90-224 Hex Bolt 5/16" x 2"  
 #98-116 Flat Washer  
 #98-170 Spacer  
 #94-116 Serrated Nut

**HARDWARE USED**

**4x FOR MIDDLE BRACKET**

#90-204 Hex Bolt 5/16" x 3/4"  
 #98-116 Flat Washer  
 #94-116 Serrated Nut

# PHASE 2 – INSTALLATION

## 2.2 MARK HOLE FOR PLUSNUT

2.2.1 After attaching the brackets mark the holes on the wall brackets and feet to the vehicle.

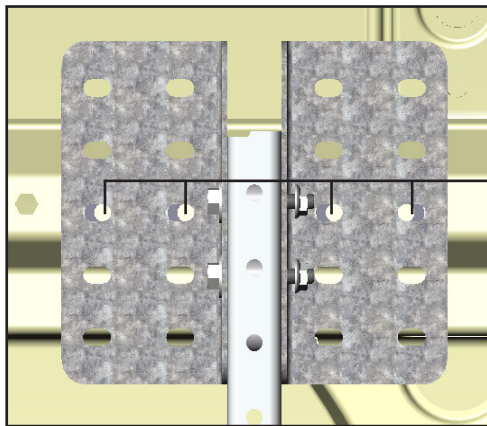
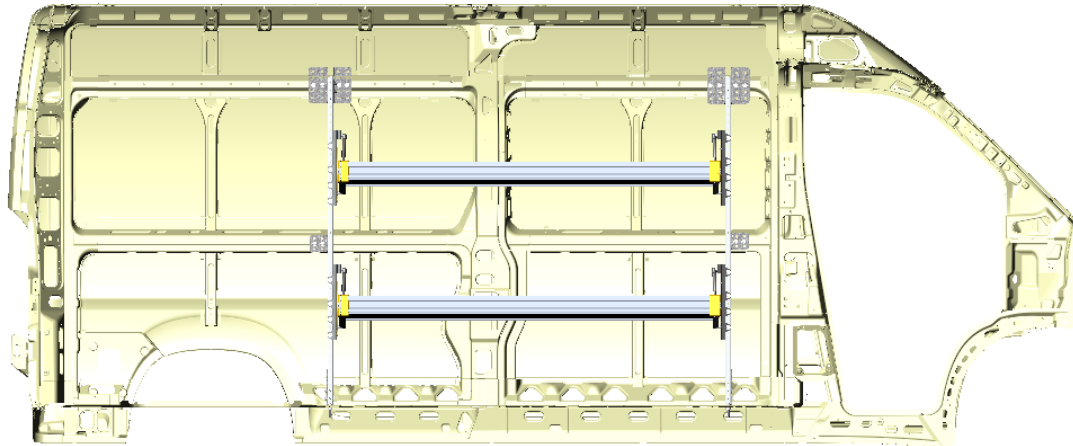

Mark 2 holes of the top and middle wall brackets on the vehicle horizontal rim.

MARK

### TOOLS

□ Marker

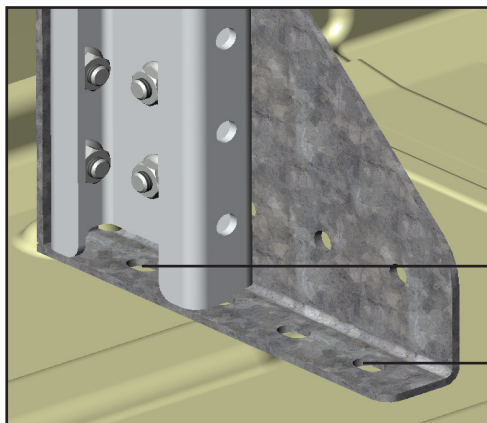

Mark the 2 holes of the feet on the vehicle floor.

MARK

# PHASE 2 – INSTALLATION

## 2.3 ATTACH PLUSNUTS

- 2.3.1**
- Lift the assembled fold-away on the side.
  - Drill all the mark using 1/2" drill bit w/ drill collar, then attach plusnuts to the holes.

**NOTE:** Use 1/2" drill bit with drill collar to stop drill at 1/2" depth.

**WARNING:** Before drilling, ensure that you will not hit any critical parts of the vehicle like the **Gas tank**, **Wiring Harness** and **Hose**.

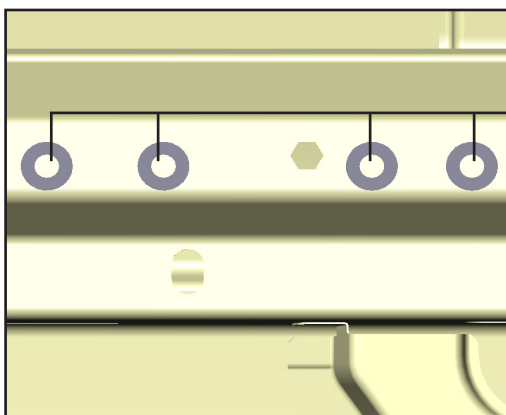
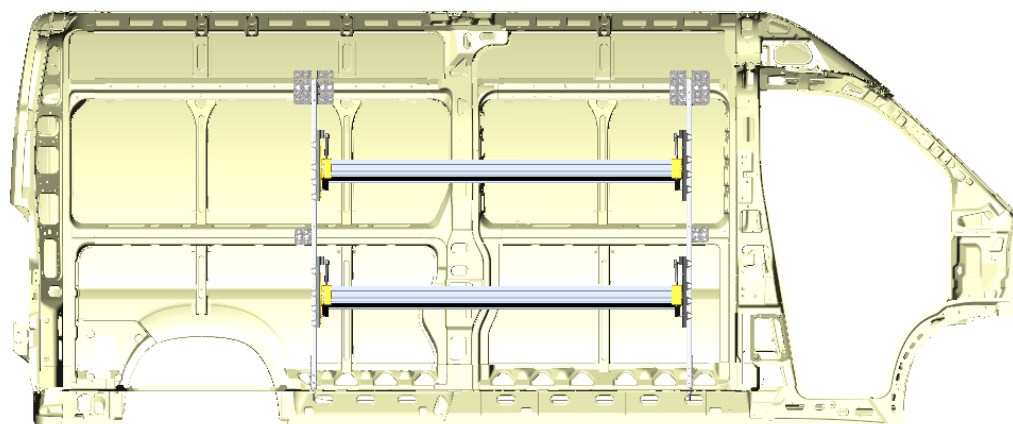

**PLUS NUT**

Drill all the marks then, attach plusnuts to the holes.

### TOOLS

- Cordless Drill
- 1/2" Drill Bit w/ Drill Collar ( Set at 1/2" )
- Plusnut Tool ( 5/16" )

### HARDWARE USED

**14x**



#94-132 Plusnut

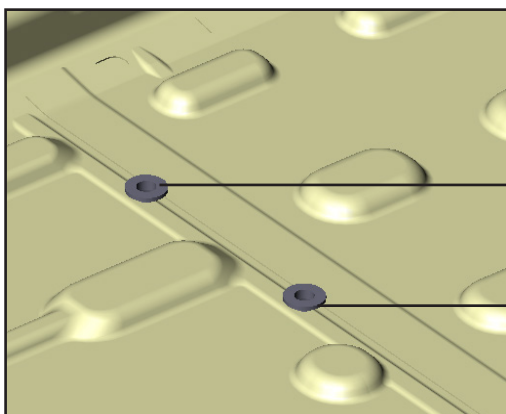

**DRILL COLLAR**  
( SET AT 1/2" )

### 2.3.2 How to attach plusnut.

#### • USING PLUSNUT GUN

**STEP:** Put the plusnut on the plusnut gun, then attach the plusnut in the hole by turning the gun forward until the plusnut locks, then remove the gun by turning in reverse.

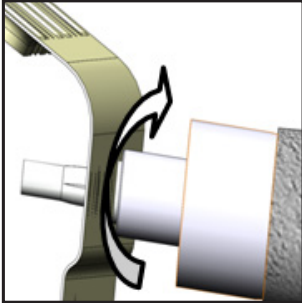

**FORWARD**

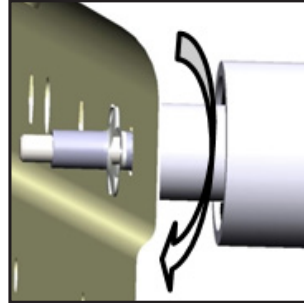

**REVERSE**

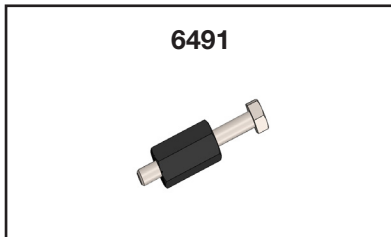

#### • USING THE 6491 PLUSNUT TOOL

**NOTE:** The hardware used for the 6490 plusnut tool is not included in the fastener bag.  
The 6490 plusnut tool can be ordered separately upon demand at no charge.



**6491**

#### HARDWARE USED

-  Flat washer 5/16"
-  Flat washer 5/16" BS x 7/8" OD

#### TOOLS

- Cordless Impact
- 1/2" Socket
- 9/16" Wrench

#### STEP 1:

Assemble the 6491 plusnut tool with the hardware needed, plus nut and the 9/16" wrench as shown.



#### STEP 2:

Attach the plusnut in the hole by turning the bolt forward using an impact with a 1/2" socket until the plusnut locks, then remove the bolt by turning the impact in reverse.

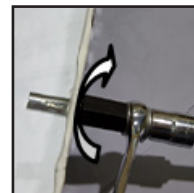

**FORWARD**

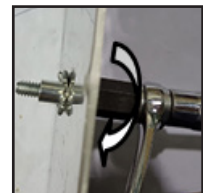

**REVERSE**

# PHASE 2 – INSTALLATION

## 2.4 FOLD-AWAY INSTALLATION

**2.4.1** Put the assembled fold-away back in place aligning the holes to the plusnuts, then install the wall brackets and feet to the plusnuts.

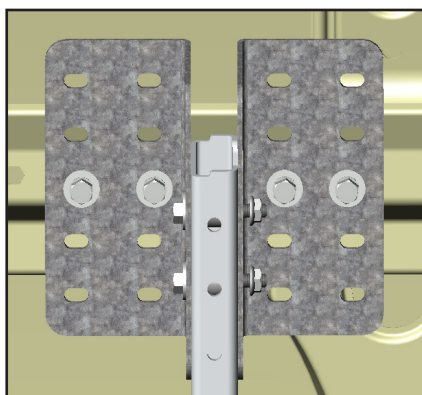
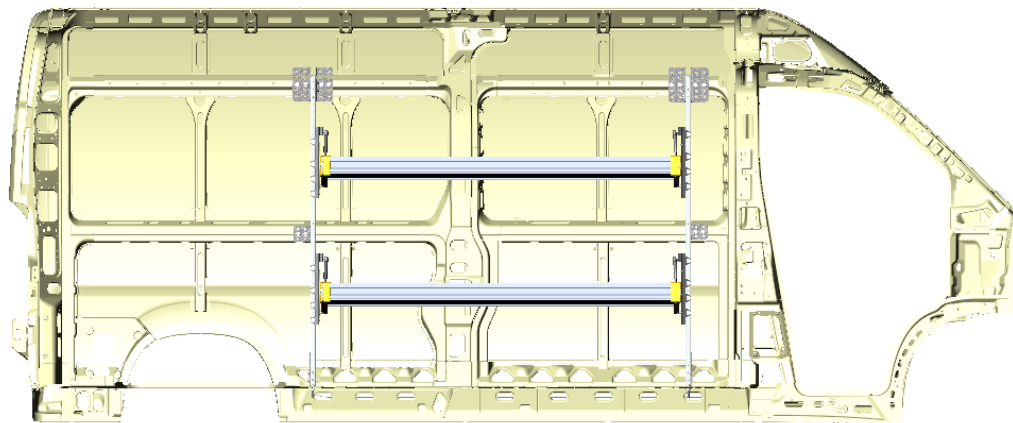





### TOOLS

- Cordless Impact
- 1/2" Socket

### HARDWARE USED



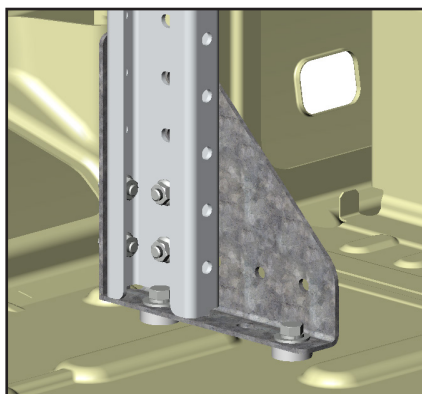

**12x** FOR WALL BRACKET

-  #90-212 Hex Bolt 5/16" x 1-1/4"
-  #98-122 Lock Washer
-  #98-116 Flat Washer
-  #94-132 Plusnut



### HARDWARE USED

**4x** FOR FEET

-  #90-011 Hex Bolt 5/16" x 1-3/4"
-  #98-122 Lock Washer
-  #98-116 Flat Washer
-  #98-157 Spacers  
( QTY = GAP BETWEEN FLOOR AND FEET )
-  #94-132 5/16" Plusnut

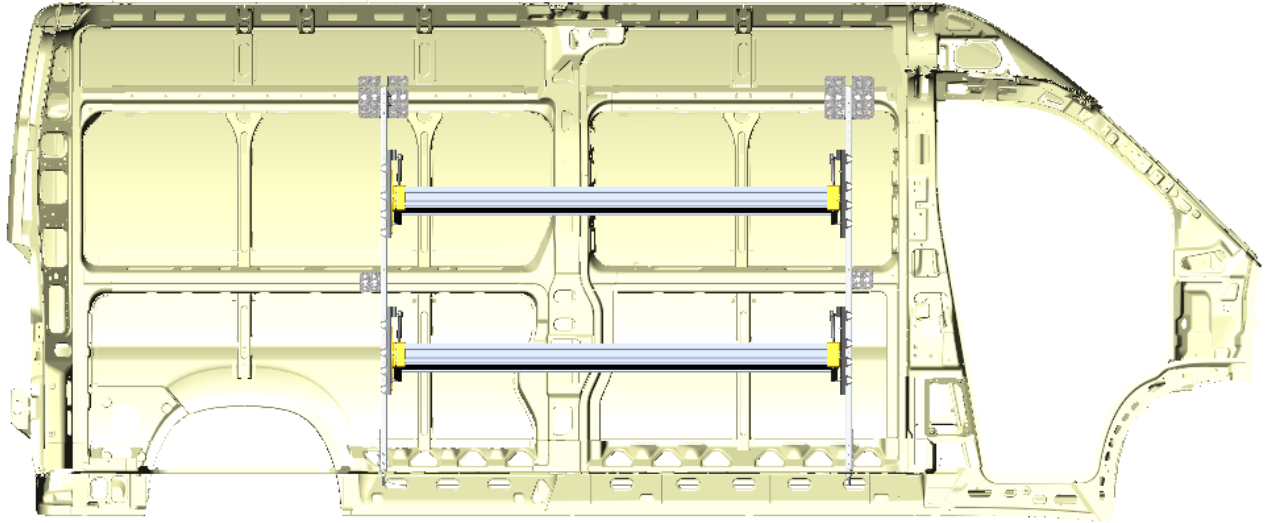

**“You have successfully installed your  
Fold-Away**

**Thank you for doing business with us.”**

For any feedback or suggestions you may have, please contact: [cs@rangerdesign.com](mailto:cs@rangerdesign.com)

