

INSTALLATION GUIDE

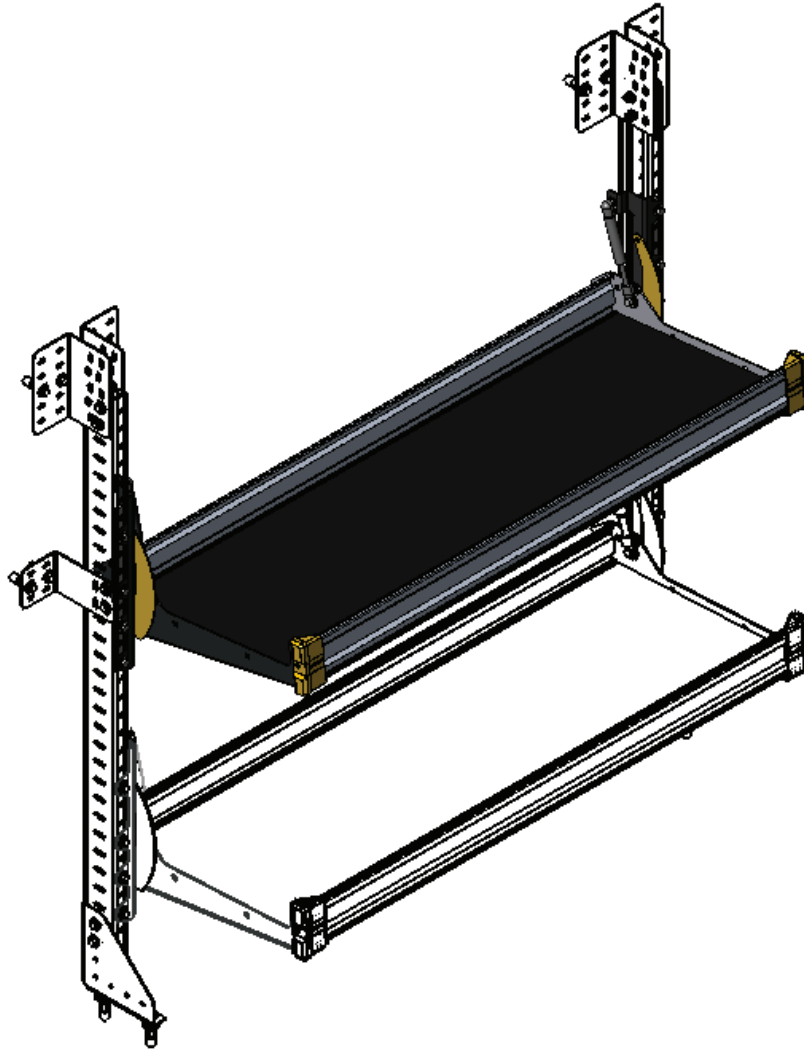

84-U1872 Fold-Away Shelf Tray



Scan the QR for the latest Install-Guide.

RANGER
DESIGN



BEFORE YOU BEGIN

READ, UNDERSTAND, AND FOLLOW ALL WARNINGS AND INSTRUCTIONS BEFORE USING THIS PRODUCT. FAILURE TO FOLLOW THESE DIRECTIONS MAY RESULT IN PROPERTY DAMAGE, SERIOUS BODILY INJURY, AND/OR DEATH. RANGER DESIGN IS NOT RESPONSIBLE FOR ANY PROPERTY DAMAGE, PERSONAL INJURY, OR DEATH THAT OCCURRED WHILE USING ANY RANGER DESIGN PRODUCTS.



WARNING

- Failure to use Ranger Design-provided fasteners, brackets, and proper installation guidelines could increase risk of serious personal injury and/or death.
- If drilling is required to complete this installation: improper drilling can cause property damage to vehicles and could lead to electric shock, fire, or even death.
- If drilling is required to complete this installation: Ensure that drilling is only performed on areas of the vehicle allowed by the vehicle's Original Equipment Manufacturer's Body Builders Layout Book (or equivalent document).
- Prior to installation, inspect the vehicle to ensure that installation will not interfere with, or cause obstruction of, any critical components such as electrical wiring, fuel tanks, fuel-cells, locks, latches, etc.
- The installer or manufacturer is responsible for ensuring anchorages are installed onto suitable wall and floor structures; wall and floor strength must meet applicable performance requirements.
- Do not install systems into any weak or unsound materials such as plastics, woods, thin-walled metals, etc. without proper reinforcement.
- Do not install this product where it could interfere with the deployment of airbags. Failure to comply could result in death or serious injury.
- Do not install this product where it could ingress on the Transit Occupant Protection Zone. Failure to comply could result in death or serious injury.
- Incorrect installation could cause water leaks, electric shock or fire.
- Any cargo vehicle with any cargo or equipment should use a certified partition. See Ranger Design website for some partition options. (<https://rangerdesign.com/>)
- Mountings rails are recommended for any attachment to the vehicle walls.
- All items in the cargo area should be properly secured and partition doors closed while the vehicle is in motion.
- Check your vehicle's tare weight and remaining load capacity with all the equipment installed. Never exceed the maximum Gross Vehicle Weight Rating (GVWR), Gross Axle Weight Ratings (GAWRs), or other maximum loads permitted by the vehicle's Original Equipment Manufacturer (OEM) and required by law.
- The heaviest items must be placed towards the bottom of the vehicle, while the lightest ones can be arranged upwards. Vehicle cargo loading weight proportion should follow the following guidelines:

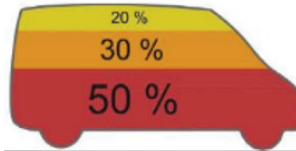

- The final alterer and/ or modifier should review the warning sheet with the customer before the vehicle is released to the customer or for general use. These instructions should remain with the vehicles a all times.
- Any modification or unintended use of this product voids any warranty and could create a hazardous condition.
- Ranger Design provides recommended assembly and installation instructions which should be followed to ensure correct operation. Failure to do so could result in invalidating the product's compliance, warranty and cause injury. Notwithstanding, the final stage vehicle alterer and/or modifier is responsible for the integration, installation, and compliance of the product in its final location to all applicable regulations and standards. Failure to maintain compliance of the vehicle to applicable regulations and standards could be punishable by law. Alterers and/or modifiers should consult with all local authorities prior to commissioning.



CAUTION

- Drilling is required to complete this installation. Before drilling, ensure that you will not hit any critical parts of the vehicle like the gas tank, wiring harness, or hose. Consult the vehicle OEM documentation as necessary. When drilling, use a drill collar to reduce the risk of damage to the vehicle.
- Any materials, padding, or glazing installed in the vehicle must comply with FMVSS/CMVSS 201/205/302, as applicable.
- In the event of a motor vehicle accident or collision where a Ranger system has been installed, especially ones where the vehicle structure is damaged and/or the air bags deploy and/or the vehicle has been towed, the system must be inspected to ensure continued soundness and safety before returning the vehicle to service. Damaged components should be replaced as necessary.
- All system components should be regularly inspected, cleaned, and maintained pursuant to Ranger guidelines.

QUICK START GUIDE

Phase 1 - Assembly

- 1.1 Setup..... 4
- 1.2 Fold-Away Shelf Tray Assembly..... 6

REQUIRED ITEMS

- Cordless Impact
- Tape Measure
- 1/2" Socket
- 3/8" Driver Bit
- Knife

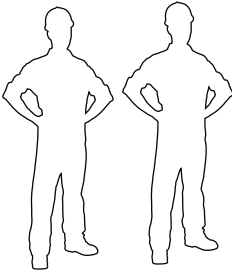

**2
PERSONS**

PHASE 1 – ASSEMBLY

1.1 SETUP

1.1.1 Unpack components; compare with the bill of materials.

84-U1872

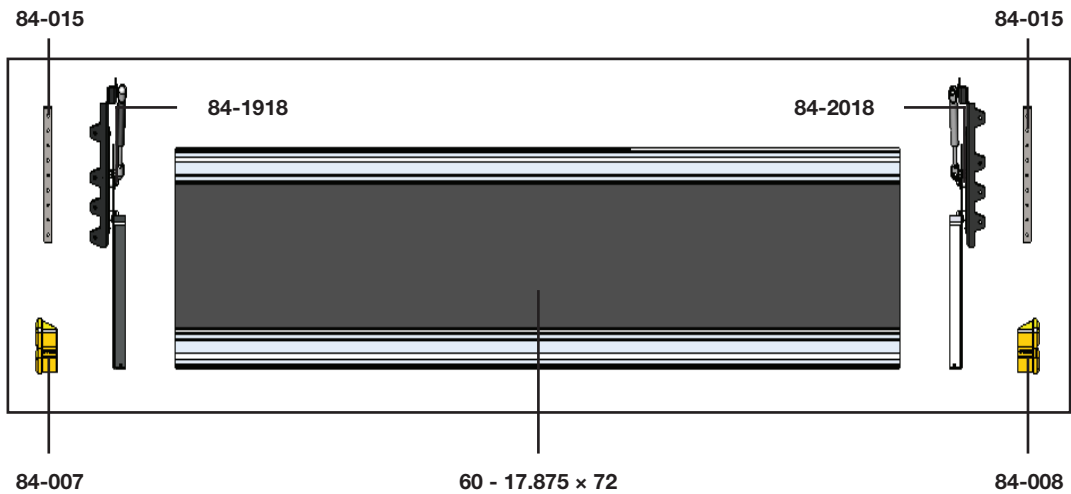

1.1.2 Verify all parts are present.

Item No.	Description	Qty.
84-007	End Cap (Left)	1
84-008	End Cap (Right)	1
84-015	Threaded Plate	2
84-1918	End Panel (Left)	1
84-2018	End Panel (Right)	1
60-17.875x72	Shelf Tray	1
94-3056	Assembly Fastener Kit	1
96-3038	Install Fastener Kit	1

94-3056



Fastener Assembly

8x



92-102

Screw HWH
#14 x 1"
ZINC

8x



#92-102 Screw #14 x 1"

4x



96-204

Multi-grip alum/steel
3/16" x 1/2"

4x



#96-204 Closed Rivet

96-3038

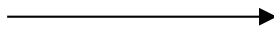

Fastener Assembly

8x



90-204

Hex Bolt
5/16"-18 x 3/4"
GR-5 ZINC

8x



#90-204 Hex Bolt 5/16" x 3/4"

8x



98-116

Flat Washer
5/16"
ZINC



#98-122 Lock Washer

8x



98-122

Lock Washer
5/16"
ZINC



#98-116 Flat Washer

PHASE 1 – ASSEMBLY

1.2 FOLD-AWAY ASSEMBLY

1.2.1 Screw the left and right end panels to the shelf tray.

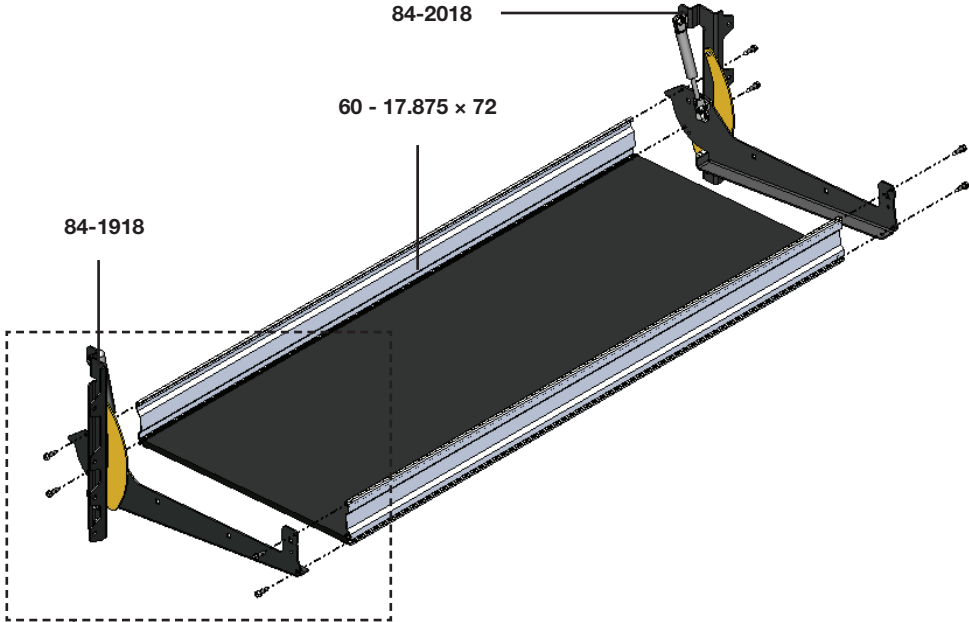

TOOLS

- Cordless Impact
- 3/8" Driver Bit

HARDWARE USED

8x

	#92-102 Screw #14 x 1"
---	------------------------

1.2.2 Rivet the end caps on the front edge of the shelf tray.

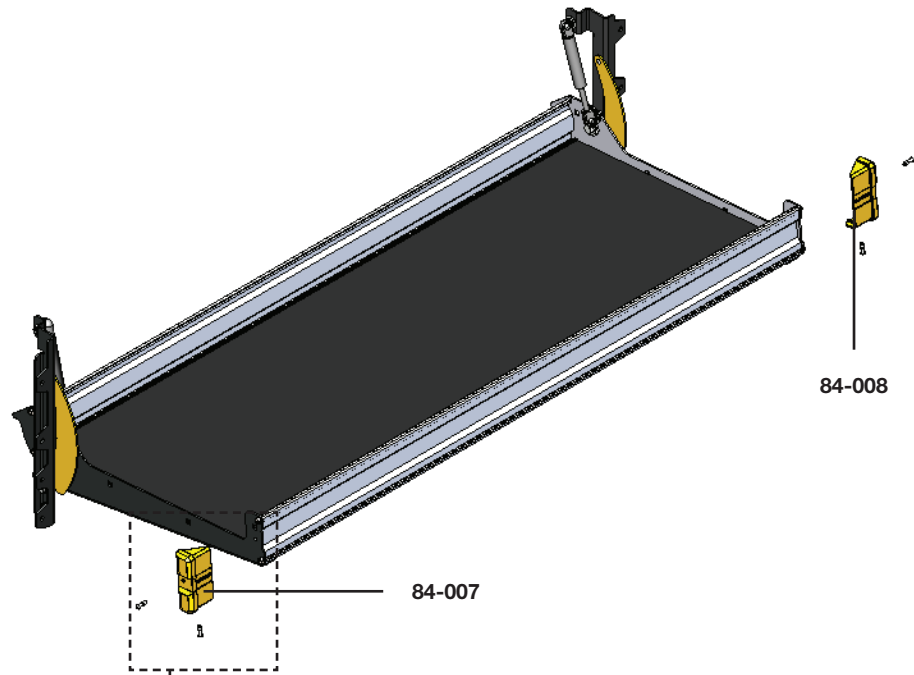

TOOLS

- Rivet Gun

HARDWARE USED

4x

	#96-204 Closed Rivet
---	----------------------

1.2.4 Attach the shelf trays to the posts.

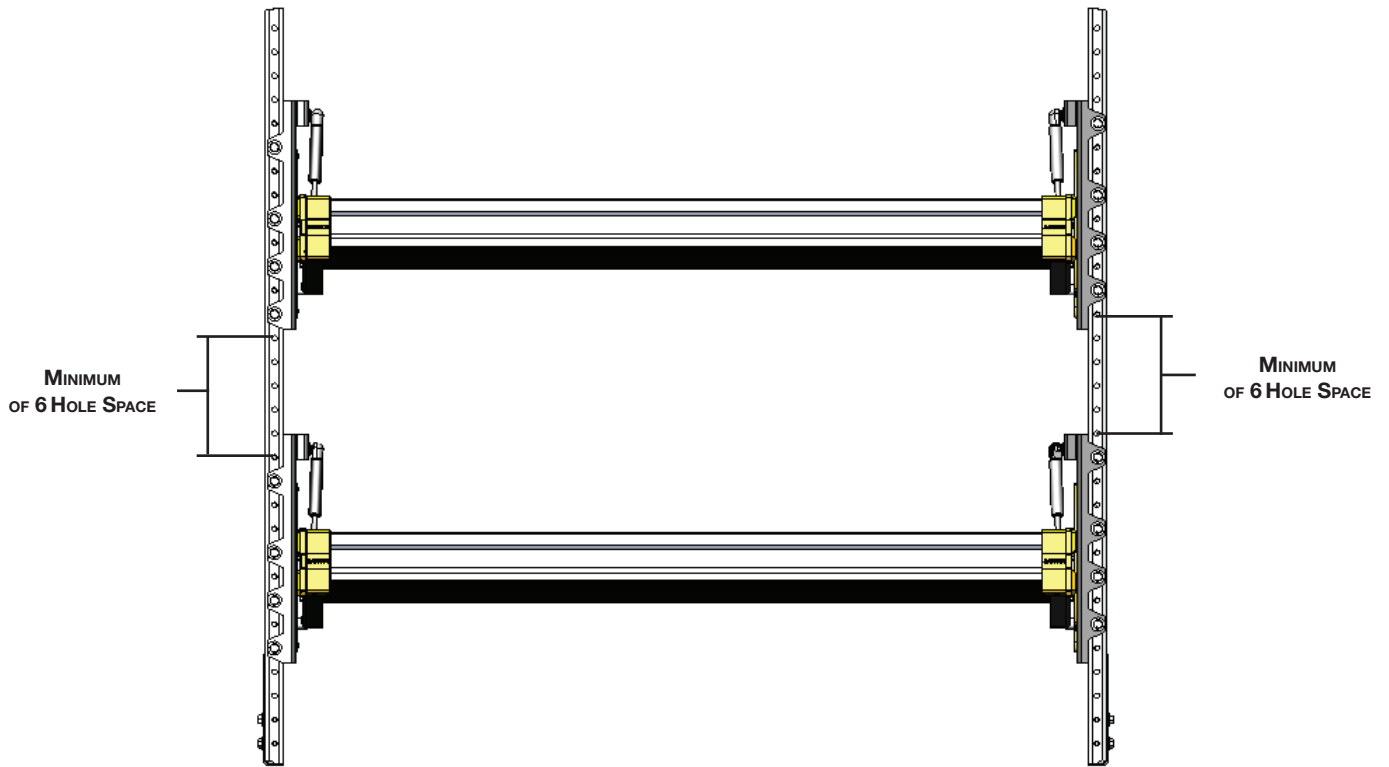



TOOLS

- Cordless Impact
- 1/2" Socket

HARDWARE USED

16x

	#90-204 Hex Bolt 5/16" x 3/4"
	#98-122 Lock Washer
	#98-116 Flat Washer

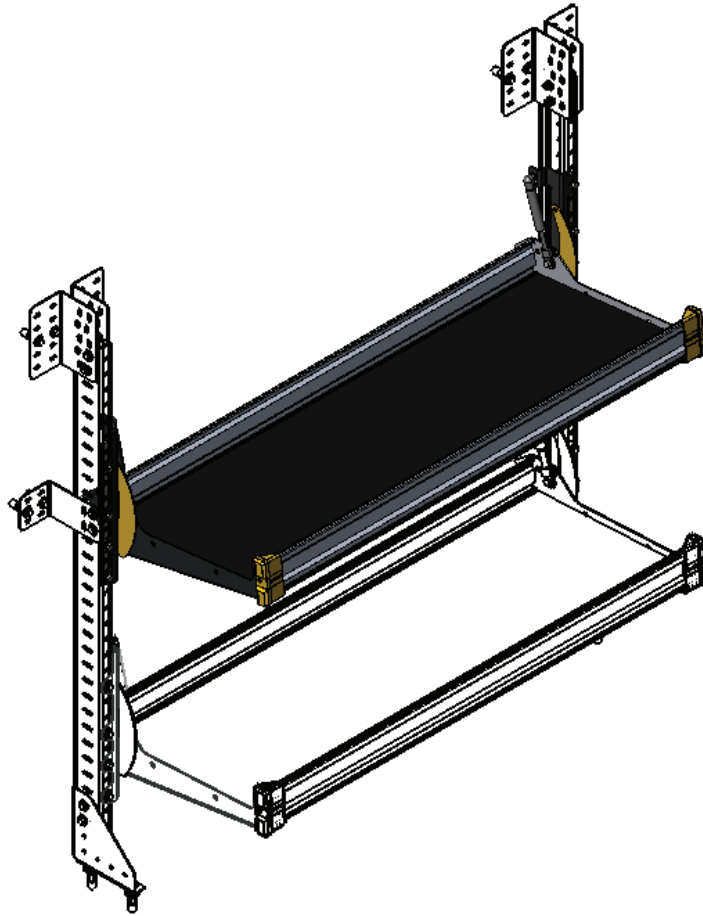

**“You have successfully installed your
Fold-Away Shelf Tray**

Thank you for doing business with us.”

For any feedback or suggestions you may have, please contact: cs@rangerdesign.com

